

Panasonic®

Operating Instructions Basic Guide

Touch Screen LCD Display For business use

English

Model No. TH-75BQ1W 75-inch model
TH-65BQ1W 65-inch model

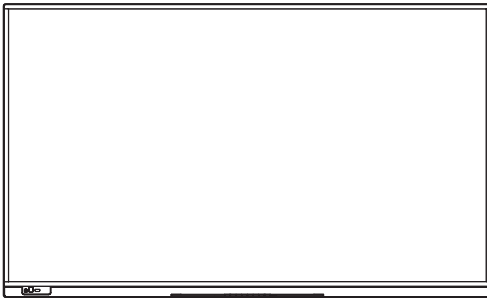

Contents

Important Safety Instructions	2
FCC STATEMENT	3
Important Safety Notice	4
Safety Precautions	5
Precautions for use	8
Accessories	10
Cautions when moving	13
Eyebolt	14
Connections	15
Identifying Controls	19
Basic Controls	21
Specifications	24
Software License	26
PANASONIC PROFESSIONAL DISPLAY Limited Warranty	27
LIMITED WARRANTY STATEMENT	28

Read before use

For more information about this product, please read the "Operating Instructions – Functional Manual".

To download the "Operating Instructions – Functional Manual", please visit the Panasonic website (<https://panasonic.net/cns/prodisplays/>).

- Please read these instructions before operating your set and retain them for future reference.
- Illustrations and screens in this Operating Instructions are images for illustration purposes, and may be different from the actual ones.
- Descriptive illustrations in this Operating Instructions are created mainly based on the 75-inch model.

4K
PROFESSIONAL
*Actual resolution:
3840 × 2160p

HDMI™

HEVC Advance™
Covered by Patents at patentlist.hevcadvance.com



WARNING
RISK OF ELECTRIC SHOCK
DO NOT OPEN



WARNING: To reduce the risk of electric shock, do not remove cover or back.

No user-serviceable parts inside. Refer servicing to qualified service personnel.



The lightning flash with arrow-head within a triangle is intended to tell the user that parts inside the product are a risk of electric shock to persons.



The exclamation point within a triangle is intended to tell the user that important operating and servicing instructions are in the papers with the appliance.

WARNING:

To prevent damage which may result in fire or shock hazard, do not expose this apparatus to rain or moisture.

Do not place containers with water (flower vase, cups, cosmetics, etc.) above the set. (including on shelves above, etc.)

WARNING:

- 1) To prevent electric shock, do not remove cover. No user serviceable parts inside. Refer servicing to qualified service personnel.
- 2) Do not remove the grounding pin on the power plug. This apparatus is equipped with a three pin grounding-type power plug. This plug will only fit a grounding-type power outlet. This is a safety feature. If you are unable to insert the plug into the outlet, contact an electrician.
Do not defeat the purpose of the grounding plug.

Important Safety Instructions

- 1) Read these instructions.
- 2) Keep these instructions.
- 3) Heed all warnings.
- 4) Follow all instructions.
- 5) Do not use this apparatus near water.
- 6) Clean only with dry cloth.
- 7) Do not block any ventilation openings. Install in accordance with the manufacturer's instructions.
- 8) Do not install near any heat sources such as radiators, heat registers, stoves, or other apparatus (including amplifiers) that produce heat.
- 9) Do not defeat the safety purpose of the polarized or grounding-type plug. A polarized plug has two blades with one wider than the other. A grounding type plug has two blades and a third grounding prong. The wide blade or the third prong are provided for your safety. If the provided plug does not fit into your outlet, consult an electrician for replacement of the obsolete outlet.
- 10) Protect the power cord from being walked on or pinched particularly at plugs, convenience receptacles, and the point where they exit from the apparatus.
- 11) Only use attachments / accessories specified by the manufacturer.
- 12) Use only with the cart, stand, tripod, bracket, or table specified by the manufacturer, or sold with the apparatus. When a cart is used, use caution when moving the cart / apparatus combination to avoid injury from tip-over. 
- 13) Unplug this apparatus during lightning storms or when unused for long periods of time.
- 14) Refer all servicing to qualified service personnel. Servicing is required when the apparatus has been damaged in any way, such as power-supply cord or plug is damaged, liquid has been spilled or objects have fallen into the apparatus, the apparatus has been exposed to rain or moisture, does not operate normally, or has been dropped.
- 15) To prevent electric shock, ensure the grounding pin on the AC cord power plug is securely connected.

FCC STATEMENT

This equipment has been tested and found to comply with the limits for a class A digital device, pursuant to Part 15 of the FCC Rules. These limits are designed to provide reasonable protection against harmful interference when the equipment is operated in a commercial environment. This equipment generates, uses and can radiate radio frequency energy and, if not installed and used in accordance with the instructions manual, may cause harmful interference to radio communications. Operation of this equipment in a residential area is likely to cause harmful interference in which case the user will be required to correct the interference at his own expense.

FCC CAUTION:

To assure continued compliance, follow the attached installation instructions and use only the provided power supply cord. Any changes or modifications not expressly approved by Panasonic Corp. of North America could void the user's authority to operate this device.

Supplier's Declaration of Conformity

Model No.

TH-75BQ1W, TH-65BQ1W

Responsible Party:

Panasonic Corporation of North America

Two Riverfront Plaza, Newark, New Jersey
07102-5490

Contact Source:

Panasonic Connect North America
1-877-655-2357

General Contact:

<http://shop.panasonic.com/support>

This device complies with Part 15 of the FCC Rules and all applicable IC RSS standards. Operation is subject to the following two conditions: (1) This device may not cause harmful interference, and (2) this device must accept any interference received, including interference that may cause undesired operation.

CANADIAN NOTICE:

This Class A digital apparatus complies with Canadian ICES-003.

WARNING:

- Not for use in a computer room as defined in the Standard for the Protection of Electronic Computer/ Data Processing Equipment, ANSI/NFPA 75.
- For permanently connected equipment, a readily accessible disconnect device shall be incorporated in the building installation wiring.
- For pluggable equipment, the socket-outlet shall be installed near the equipment and shall be easily accessible.

Note:

Image retention may occur. If you display a still picture for an extended period, the image might remain on the screen. However, it will disappear when a general moving picture is displayed for a while.

Trademark Credits

- Microsoft, Windows, Internet Explorer and Microsoft Edge are the registered trademarks or trademarks of Microsoft Corporation in the United States and/or other countries.
- Mac, macOS and Safari are the trademarks of Apple Inc. registered in the United States and other countries.
- PJLink is a registered or pending trademark in Japan, the United States, and other countries and regions.
- HDMI, High-Definition Multimedia Interface and the HDMI Logo are trademarks or registered trademarks of HDMI Licensing Administrator, Inc. in the United States and other countries.
- JavaScript is a registered trademark or a trademark of Oracle Corporation and its subsidiary and associated companies in the United States and/or other countries.
- Crestron Connected, Crestron Connected logo, Crestron Fusion, Crestron RoomView and RoomView are trademarks or registered trademarks of Crestron Electronics, Inc. in the United States and/or other countries.

Even if no special notation has been made of company or product trademarks, these trademarks have been fully respected.

Important Safety Notice

WARNING

- 1) To prevent damage which may result in fire or shock hazard, do not expose this appliance to dripping or splashing.
Do not place containers with water (flower vase, cups, cosmetics, etc.) above the set. (including on shelves above, etc.)
No naked flame sources, such as lighted candles, should be placed on / above the set.
- 2) To prevent electric shock, do not remove cover. No user serviceable parts inside. Refer servicing to qualified service personnel.
- 3) Do not remove the earthing pin on the power plug. This apparatus is equipped with a three pin earthing-type power plug. This plug will only fit an earthing-type power outlet. This is a safety feature. If you are unable to insert the plug into the outlet, contact an electrician.
Do not defeat the purpose of the earthing plug.
- 4) To prevent electric shock, ensure the earthing pin on the AC cord power plug is securely connected.

CAUTION

This appliance is intended for use in environments which are relatively free of electromagnetic fields.

Using this appliance near sources of strong electromagnetic fields or where electrical noise may overlap with the input signals could cause the picture and sound to wobble or cause interference such as noise to appear.

To avoid the possibility of harm to this appliance, keep it away from sources of strong electromagnetic fields.

WARNING:

This equipment is compliant with Class A of CISPR32. In a residential environment this equipment may cause radio interference.

IMPORTANT INFORMATION: Stability Hazard

Never place a display in an unstable location. A display may fall, causing serious personal injury or death. Many injuries, particularly to children, can be avoided by taking simple precautions such as:

- Using cabinets or stands recommended by the manufacturer of the display.
- Only using furniture that can safely support the display.
- Ensuring the display is not overhanging the edge of the supporting furniture.
- Not placing the display on tall furniture (for example, cupboards or bookcases) without anchoring both the furniture and the display to a suitable support.
- Not placing the display on cloth or other materials that may be located between the display and supporting furniture.
- Educating children about the dangers of climbing on furniture to reach the display or its controls.

If the existing display is going to be retained and relocated, the same considerations as above should be applied.

Safety Precautions

WARNING

■ Setup

This LCD Display is for use only with the following optional accessories.

- 3G-SDI Terminal Board
TY-SB01SS
- Early Warning Software
(Basic license/3-year license):
ET-SWA100 series*

*:Suffix of the part number may differ depending on the license type.

Note

- The part number of the optional accessories are subject to change without notice.

Small parts can present choking hazard if accidentally swallowed. Keep small parts away from young children. Discard unneeded small parts and other objects, including packaging materials and plastic bags/sheets to prevent them from being played with by young children, creating the potential risk of suffocation.

Do not place the Display on sloped or unstable surfaces, and ensure that the Display does not hang over the edge of the base.

- The Display may fall off or tip over.

Install this unit at a location with minimal vibration and which can support the weight of the unit.

- Dropping or falling of the unit may cause injury or malfunction.

Caution - For use only with UL Listed Wall Mount Bracket with minimum weight/load 56.6 kg (124.8 lbs).

When installing the display vertically, be sure that the power indicator comes to the right side.



1 Power indicator

- If installed in different directions, heat is generated and it may cause fire or damage to the Display.

Cautions for Wall or Pedestal Installation

- The installation should be performed by an installation professional. Installing the Display incorrectly may lead to an accident that results in death or serious injury. Use the optional Pedestal that conforms to VESA standards must be used.

- When installing on a wall, a wall hanging bracket that conforms to VESA standards must be used.

75-inch model : VESA 600 × 400

65-inch model : VESA 400 × 400

(see page 8)

- Before installation, be sure to check if the mounting location has enough strength to support the weight of the display and the wall hanging bracket for anti drop.
- If you terminate the use of the product, ask a professional to remove it promptly.
- When mounting the Display on the wall, prevent the mounting screws and power cable from contacting metal objects inside the wall. An electric shock may occur if they contact metal objects inside the wall.

■ When using the LCD Display

The Display is designed to operate on 110 – 240 V AC, 50/60 Hz.

If problems or malfunction occur, stop using immediately.

If problems occur, unplug the power supply plug.

- Smoke or an abnormal odour come out from the unit.
- No picture appears or no sound is heard, occasionally.
- Liquid such as water or foreign objects got inside the unit.
- The unit has deformed or broken parts.

If you continue to use the unit in this condition, it could result in fire or electric shock.

- Unplug the power supply plug from the wall outlet, and then contact the dealer for repairs.
- To cut off the power supply to this Display completely, you need to unplug the power supply plug from the wall outlet.
- Repairing the unit yourself is dangerous, and shall never be done.
- To enable to unplug the power supply plug immediately, use the wall outlet which you can reach easily.

Do not touch the unit directly by hand when it is damaged.

- Electric shock could occur.

Do not stick any foreign objects into the Display.

- Do not insert any metal or flammable objects into the ventilations holes or drop them onto the Display, as doing so can cause fire or electric shock.

Do not remove the cover (cabinet) or modify it.

- High voltages which can cause fire or electric shocks are present inside the Display. For any inspection, adjustment and repair work, please contact your local Panasonic dealer.

Ensure that the mains plug is easily accessible.

The mains plug shall be connected to a mains socket outlet with a protective earthing connection.

Do not use any power supply cord other than that provided with this unit.

- Doing so may cause short-circuit, generates heat, etc., which could cause electric shock or fire.

Do not use the supplied power supply cord with any other devices.

- Doing so may cause short-circuit, generates heat, etc., which could cause electric shock or fire.

Clean the power supply plug regularly to prevent it becoming dusty.

- If there is a build up of dust on the plug, the resultant humidity may cause short-circuit, which could cause electric shock or fire. Unplug the power supply plug from the wall outlet and wipe it with a dry cloth.

Do not handle the power supply plug with wet hands.

- Doing so may cause electric shocks.

Securely insert the power supply plug (socket outlet side) and the power supply connector (main unit side) as far as it will go.

- If the plug is not fully inserted, heat may be generated which could cause fire. If the plug is damaged or the wall socket is loose, they shall not be used.

Do not do anything that may damage the power supply cord or the power supply plug.

- Do not damage the cable, make any modifications to it, place heavy objects on top of it, heat it, place it near any hot objects, twist it, bend it excessively or pull it. To do so may cause fire and electric shock. If the power cable is damaged, have it repaired at your local Panasonic dealer.

Do not touch the power supply cord or the plug directly by hand when they are damaged.

- Doing so may cause electric shock or fire due to short-circuit.

Keep the supplied AAA/R03/LR03 batteries, out of reach of children. If accidentally swallowed, it will be harmful to the body.

- Please contact a doctor immediately in case you doubt that the child may have swallowed it.

When using the unit in an area where there are passers-by, do not connect the USB cable for the touch panel or HDMI cable to the external device.

Doing so may cause them to bump into the unit, or their feet may be entangled in the USB cable or HDMI cable, resulting in a fire, electric shock or injury.

- When using the unit in an area where there are passers-by, provide an enclosure around the unit to prevent people from approaching it.

To prevent the spread of fire, keep candles or other open flames away from this product at all times.



CAUTION

Do not place any objects on top of the Display.

Ventilation should not be impeded by covering the ventilation openings with items such as newspapers, table cloths and curtains.

- Doing so may cause the Display to overheat, which can cause fire or damage to the Display.

For sufficient ventilation, see page 8.

Do not place the display where it may be affected by salt or corrosive gas.

- Doing so may cause the display to fall due to corrosion, and it may result in injury. Also, the unit may malfunction.

The following number of people are required to carry or unpack this unit.

75-inch model : 4 or more

65-inch model : 2 or more

- If this is not observed, the unit may drop, resulting in injury.

When disconnecting the power supply cord, always pull on the plug (socket outlet side) / the connector (main unit side).

- Pulling the cord may damage the cord, and it may cause electric shock or fire due to short-circuit.

Be sure to disconnect all cables and overturn prevention accessories before moving the Display.

- If the Display is moved while some of the cables are still connected, the cables may become damaged, and fire or electric shock could result.

Do not apply too much force or impact shock.

- The front panel may crack, resulting in injury.

Disconnect the power supply plug from the wall socket as a safety precaution before carrying out any cleaning.

- Electric shocks can result if this is not done.

Do not step on, or hang from the display or the Pedestal.

- They might tip over, or might be broken and it may result in injury. Pay special attention to the children.

Do not reverse the polarity (+ and -) of the battery when inserting.

- Mishandling the battery may cause its explosion or leakage, resulting in fire, injury or damage to surrounding properties.
- Insert the battery correctly as instructed. (see page 11)

Do not use batteries with the outer cover peeling away or removed.

- Mishandling the batteries may cause the batteries to short circuit, resulting in fire, injury or damage to surrounding properties.

Remove the batteries from the remote control transmitter when not using for a long period of time.

- The battery may leak, heat, ignite or burst, resulting in fire or damage to surrounding properties.

Remove exhausted batteries from the remote control immediately.

- Leaving the batteries unattended in it may cause battery leakage, heat or burst.

Do not burn or breakup batteries.

- Batteries must not be exposed to excessive heat such as sunshine, fire or the like.

Do not turn the Display upside down.

Do not position the unit with its front crystal panel facing upright.

Precautions for use

Cautions when installing

Do not set up the Display outdoors.

- The Display is designed for indoor use.

Install this unit at a location which can support the weight of the unit.

- Dropping or falling of the unit may cause injury.

Environmental temperature to use this unit

- When using the unit where it is below 1 400 m (4 593 ft) above sea level: 0 °C to 40 °C (32 °F to 104 °F)
- When using the unit at high altitudes (1 400 m (4 593 ft) and higher and below 2 800 m (9 186 ft) above sea level): 0 °C to 35 °C (32 °F to 95 °F)

Do not install the unit where it is 2 800 m (9 186 ft) and higher above sea level.

- Failure to do so may shorten the life of the internal parts and result in malfunctions.

We are not responsible for any product damage, etc. caused by failures in the installation environment even during the warranty period.

Transport only in upright position!

- Transporting the unit with its front panel facing upright or downward may cause damage to the internal circuitry.

Do not install the product to a place where the product is exposed to direct sunlight.

- If the unit is exposed to direct sunlight even indoors, the temperature rise of the liquid crystal panel may cause malfunction.

In the case of storage, store the unit in a dry room.

Required space for ventilation

- Operation of this unit is guaranteed up to an ambient temperature of 40 °C (104 °F). When installing the unit in a case or chassis, be sure to provide adequate ventilation with a cooling fan or ventilation hole so that the surrounding temperature (inside the case or chassis) including the temperature of the front surface of the liquid crystal panel can be kept at 40 °C (104 °F) or less.

About the screws used when using a wall hanging bracket that conforms to VESA standards

Inch model	Screw pitch for installation	Depth of screw hole	Screw (quantity)
75	600 mm × 400 mm	15 mm	M8 (4)
65	400 mm × 400 mm	15 mm	M8 (4)

Note for connection

Removing and inserting the power cord and connection cables

- When the unit has been installed on the wall, if the power cord and connection cables are difficult to remove and insert, make connections first before installation. Be careful not to allow the cables to be entangled. After installation is completed, insert the power plug to the outlet.

When using

Red, blue or green dots on the screen are a liquid crystal panel-specific phenomenon. This is not a malfunction.

- Although the liquid crystal display is manufactured with high-precision technology, always-lighting dots or non-lighting dots may appear on the screen. This is not a malfunction.

Inch model	Dot omission ratio*
75	0.00009% or less
65	0.00005% or less

*: Calculated in sub-pixel units according to the ISO9241-307 standard.

Depending on the temperature or humidity conditions, uneven brightness may be observed. This is not a malfunction.

- This unevenness will disappear while applying current continuously. If not, consult the distributor.

If the Display is not going to be used for any prolonged length of time, unplug the power supply plug from the wall outlet.

If the power is instantaneously interrupted or stopped, or if the power voltage is instantaneously lowered, the Display may not operate normally.

- In this case, turn off the power of the Display and the connected devices once, and then turn on the power again.

Picture noise may occur if you connect / disconnect the cables connected to the input terminals you are currently not watching, or if you turn the power of the video equipment on / off, but it is not a malfunction.

Notes on Using Wired LAN

When setting up the Display at a place, where electric static occurs often, take a sufficient antistatic measure before start using.

- When the Display is used at a location, where static electricity occurs often, such as on a carpet, a wired LAN communication is disconnected more often. In that case, remove static electricity and the noise source that may cause problems with an antistatic mat, and re-connect the wired LAN.
- In rare cases, the LAN connection is disabled due to static electricity or noise. In that case, turn off the power of the Display and the connected devices once and then re-turn on the power.

The Display may not work properly due to strong radio wave from the broadcast station or the radio.

- If there is any facility or equipment, which outputs strong radio wave, near the installation location, set up the Display at a location sufficiently far from the source of the radio wave. Or, wrap the LAN cable connected to the LAN terminal by using a piece of metal foil or a metal pipe, of which is grounded at both ends.

Request Regarding Security

When using this unit, take safety measures against the following incidents.

- Personal information being leaked via this unit
- Unauthorized operation of this unit by a malicious third party
- Interfering or stopping of this unit by a malicious third party

Take sufficient security measures.

- Set a password for the LAN control and restrict the users who can log in.
- Make your password difficult to guess as much as possible.
- Change your password periodically.
- Panasonic Connect Co., Ltd. or its affiliate companies will never ask for your password directly. Do not divulge your password in case you receive such inquiries.
- The connecting network must be secured by a firewall, etc.
- When disposing the product, initialize the data before disposing.

Cleaning and maintenance

First, remove the mains plug from the mains socket.

Gently wipe the surface of the front panel or cabinet by using a soft cloth to remove dirt.

- To remove stubborn dirt or fingerprints on the surface of the front panel, dampen a cloth with diluted neutral detergent (1 part detergent to 100 parts water), wring out the cloth firmly, and then wipe away the dirt. Finally, wipe away all the moisture with a dry cloth.
- If water droplets get inside the unit, operating problems may result.

Note

- The surface of the front panel is specially treated. Do not use a hard cloth or rub the surface too hard, otherwise this may cause scratches on the surface.

Usage of a chemical cloth

- Do not use a chemical cloth for the front panel surface.
- Follow the instructions for the chemical cloth to use it for the cabinet.

Avoid contact with volatile substances such as insect sprays, solvents and thinner.

- This may cause damage to the cabinet or cause peeling of the paint. Furthermore, do not leave it in contact with a rubber or PVC substance for a long time.

Touch panel

Carefully observe the following instructions as the display has an optical touch panel.

Do not expose the display to direct sunlight or strong light source during use.

- Otherwise malfunction may occur since the optical touch panel of the display uses infrared rays.

After turning on the power of the display, do not touch the IR transmission part and the screen until any image is displayed.

- Otherwise the touched part may be detected as defective elements, resulting in abnormal operation. If this occurred, turn the display off and then on.

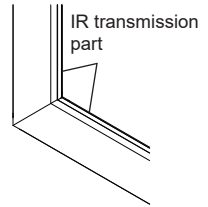

Always use a finger or the supplied pen to operate the touch panel. Do not use a hard or sharp tip such as nail, ball-point pen, and pencil.

When using any other infrared device, keep a distance to prevent erroneous operation.

When installing multiple units

When installing multiple units side by side, infrared rays of each unit may penetrate into the IR transmission parts of the adjacent displays, resulting in malfunction of touch panels.

Install the units in such a way that the displays are not affected mutually.

Distortion of the display

If the display is distorted, transmission/reception of infrared rays may be disturbed, resulting in an operational error of the touch panel.

- When installing the unit, be careful not to allow the display to be distorted while following the usage of a stand or wall hanging bracket to be used.
- When the unit is installed on a mobile stand, do not hold the display or handle to carry the unit. Doing so may cause distortion of the display.

Disposal

When disposing the product, ask your local authority or dealer about the correct methods of disposal.

Accessories

Accessories Supply

Check that you have the accessories and items shown.

Remote Control Transmitter × 1

- DPVF2713ZA/X1



Batteries for the Remote Control Transmitter × 2 (AAA/R03/LR03 type)

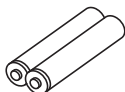

Clamper × 3

- DPVF1654ZA



SLOT adapter × 1

- DPVF2722YA/X1

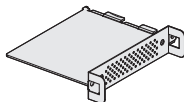

Pen × 2

- DPVF3200ZA/X1

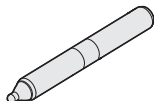

Eraser × 1

- DPVF3201ZA/X1

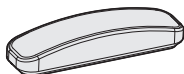

USB cable × 1

(Approx. 3 m)

- DPVF3202ZA/X1

Corner pad × 2

- DPVF3203ZA/X1 (Left)
- DPVF3204ZA/X1 (Right)



Left



Right

Power supply cord

(Approx. 2 m)

- 1JP155AF1U

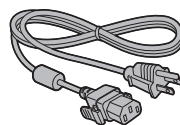

Attention

- Store small parts in an appropriate manner, and keep them away from young children.
- The part numbers of accessories are subject to change without notice. (The actual part number may differ from the ones shown above.)
- In case you lost accessories, please purchase them from your dealer. (Available from the customer service)
- Dispose the packaging materials appropriately after taking out the items.

Remote Control Batteries

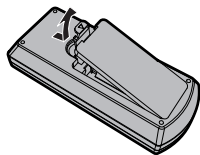

Open the battery cover.

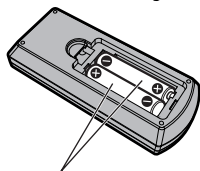

Insert batteries and close the battery cover.

(Insert starting from the  side.)

AAA/R03/LR03 type

Note

- Incorrect installation of the batteries can cause battery leakage and corrosion that will damage the remote control.
- Disposal of batteries should be done in an environment-friendly manner.

Take the following precautions.

1. Batteries shall always be replaced as a pair.
2. Do not combine a used battery with a new one.
3. Do not mix battery types (example; manganese dioxide battery and alkaline battery etc.).
4. Do not attempt to charge, disassemble or burn used batteries.
5. Do not burn or breakup batteries.
Moreover, batteries must not be exposed to excessive heat such as sunshine, fire or the like.

Attaching the corner pads

Note

- Wipe off dust, water, oil and other dirt on the attaching surface, and affix the corner pad on the attaching surface by pushing it firmly.
- A corner pad once attached cannot be reused. Be sure to confirm the attaching position before affixing.
- Note that the corner pad may come off if it is hit by an object or an external force is applied to it.

Remove the tapes on the back sides of the corner pads, and attach them to both bottom corners of the main unit firmly from below.

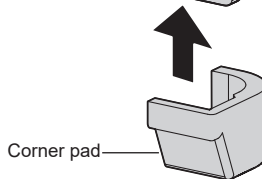
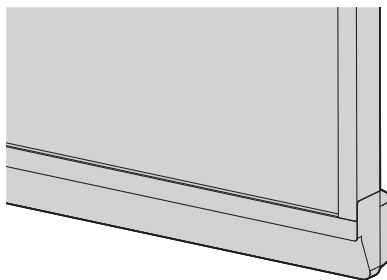

Corner pad

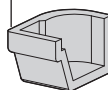

(For left)

Attaching positions of corner pads



(For right)

Attaching the Function Board

When using a narrow-width function board, attach the supplied SLOT adaptor, and insert it to the slot.

Note

- Before attaching or removing the function board, be sure to turn off the power of the display and remove the power plug from the outlet.

When attaching a full-size function board, proceed to step 4.

1 Remove one screw from the side with the guide on the SLOT adaptor.

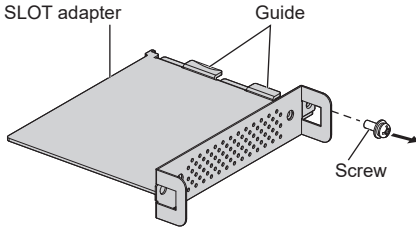

2 Fit the circuit board of the function board in the guides of the SLOT adaptor, and bring the circuit board into contact with the hook (one location) and the end faces (two locations) securely.

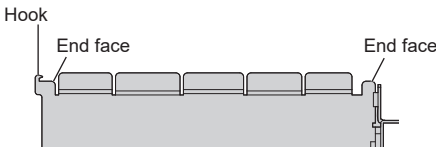
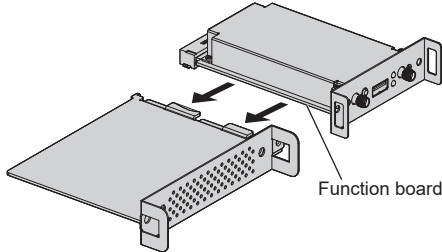

3 Using the screw removed in step 1, fix the function board to the SLOT adaptor.

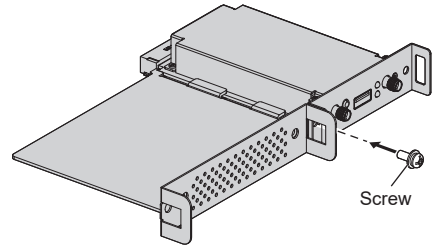

- Tightening torque guideline: 0.6 N·m or less

Note

- Firmly tighten the screw, and check that the hook of the SLOT adaptor fixes the circuit board.
- Check that the surface of the SLOT adaptor and the surface of the circuit board match with each other when the function board with the SLOT adaptor attached is viewed from the opposite side of the cover.

Make sure that this side is aligned.

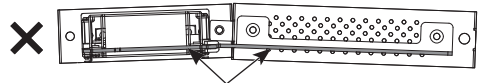
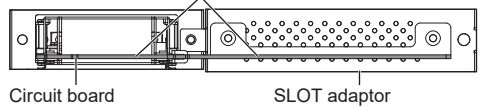

It cannot be attached unless this side is horizontally aligned.



- If there is a lead wire within approx. 3 mm from the end face of the circuit board, the function board cannot be attached due to interference with the guide rail. Ensure that there is no lead wire in this range.

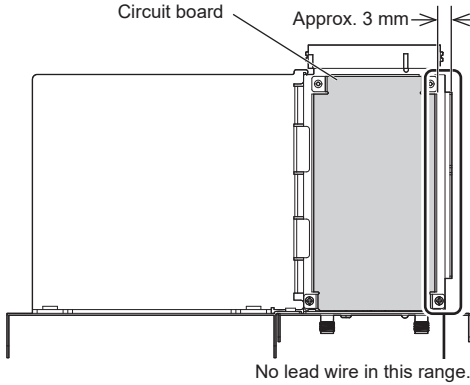

4 Remove the 2 screws from the main unit slot cover.

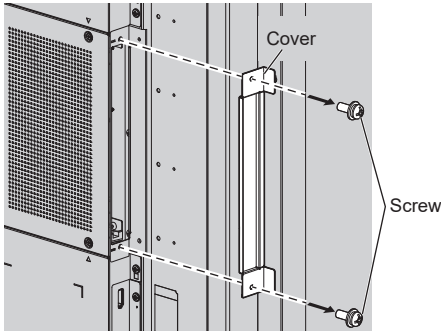

5 Insert the function board to the main unit slot, and fix it with the 2 screws removed in step 4.

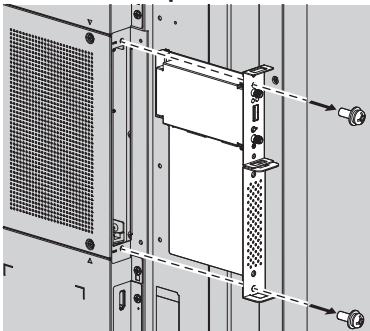

Cautions when moving

The display has handles for carrying. Hold them when moving.

75-inch model

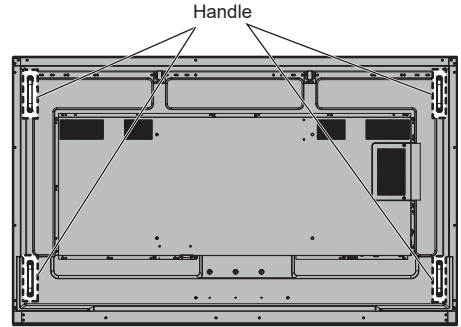

65-inch model

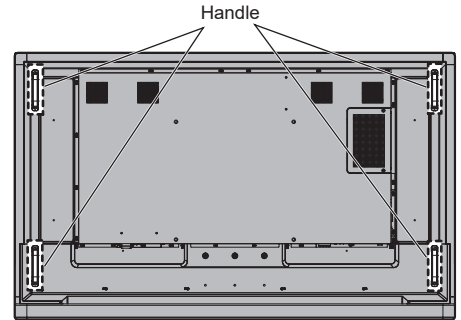

Note

- Do not hold parts other than the handles.
- The following number of people are required to carry this unit.

75-inch model : 4 or more

65-inch model : 2 or more

If this is not observed, the unit may drop, resulting in injury.

- When carrying the unit, keep the front panel upright. Carrying the unit with the surface of the front panel facing up or down may cause deformation of the panel, or internal damage.
- Do not hold the upper, lower, right and left frames or the corners of the unit. Do not hold the front surface of the panel. Also, do not hit such parts. Doing so may damage the liquid crystal panel. Also, the panel may crack, resulting in injury.

Eyebolt 75-inch model

The display has holes for attaching eyebolts (M10). When installing, use them to suspend the display. Use the eyebolt only for temporary suspension or movement for installation. This cannot be used for permanent hanging installation.

Attaching the eyebolts

Eyebolt (commercially available) mounting positions

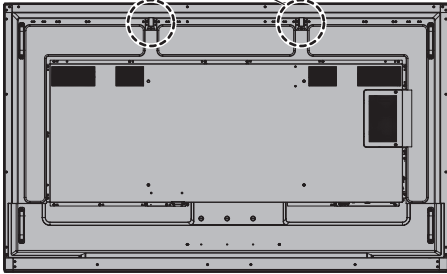

1 Remove the eyebolt cap from the eyebolt mounting position (two locations).

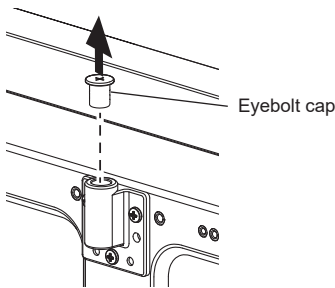

2 Attach the eyebolt to the mounting position (two locations).

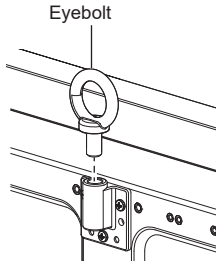

3 After removing the eyebolt, tighten the eyebolt cap.

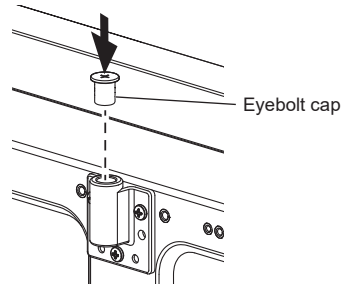

Note

- Installation should be performed by an installation professional.
- Do not suspend using only 1 eyebolt.
- Use commercially sold M10 eyebolts with a shank length of 12 mm to 40 mm that satisfies the load condition of product quality.
- Use ISO 3266 standard eyebolts. Also use ISO standard members (wire, etc.) for hanging.
- The hanging angle should be 60° or more.
- After installation, remove the eyebolts, and close the holes using the eyebolt caps removed when attaching the eyebolts.

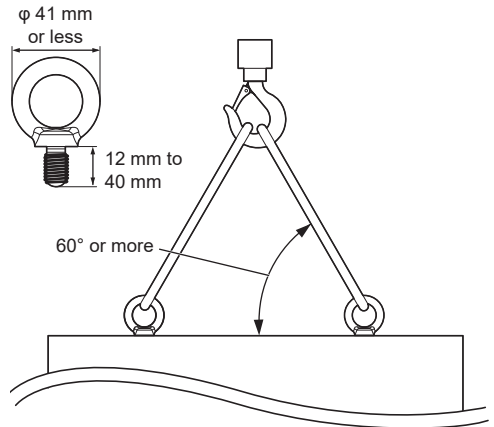

Connections

AC cord connection and fixing / Cable fixing

Back of the unit

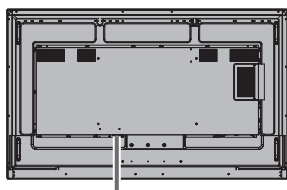

AC cord fixing

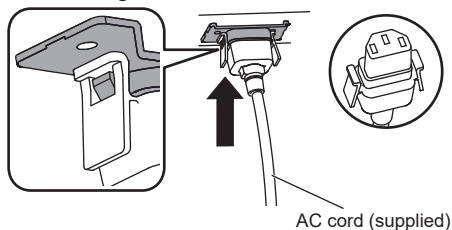

Plug the connector into the display unit.

Plug the connector until it clicks.

Note

- Make sure that the connector is locked on both the left and right sides.

Unplug the AC cord

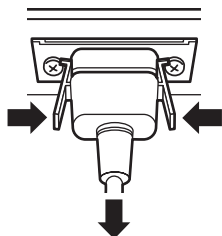

Unplug the connector pressing the two knobs.

Note

- Do not use an AC cord of which the knobs are damaged. If it is used with the knobs damaged, a bad connection may result between the AC cord connector and the AC IN terminal. For the repair of the AC cord, consult the dealer where you purchased the product.
- When disconnecting the AC cord, be absolutely sure to disconnect the AC cord plug at the socket outlet first.
- The supplied AC cord is for this unit exclusive use. Do not use this for other purposes.

Cable fixing

Note

- 3 clampers are supplied with this unit. Fix the cables using clampers (Fixation type) appropriate for each cable as shown below.

If you need more clampers, purchase them from your dealer. (Available from the customer service)

Attaching positions of the clampers (criterion)

75-inch model

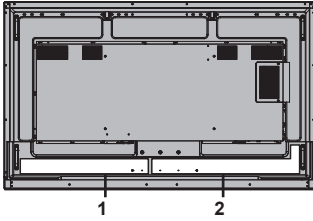

65-inch model

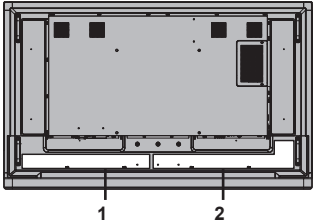

1 For AC cord: clamper

2 For signal cable: clamper

1. Attach the clamper

Note

- Wipe off dirt, such as dust, water and oil on the attachment surface, and affix the clamper on the attachment surface by pushing it firmly.
- Once the clamper is affixed, it cannot be reused. Be sure to confirm the attaching position before affixing it.

Remove the tape at the back, and affix the clamper on the flat surface.

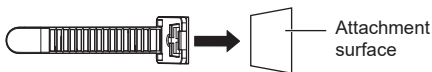

2. Bundle the cables

Pass the tip of the band to the hooks. Then pull and hook it on the knob.

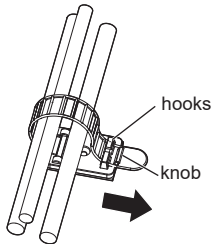

To loosen:

Remove the band from the knob, and pull out the band tip.

Video equipment connection

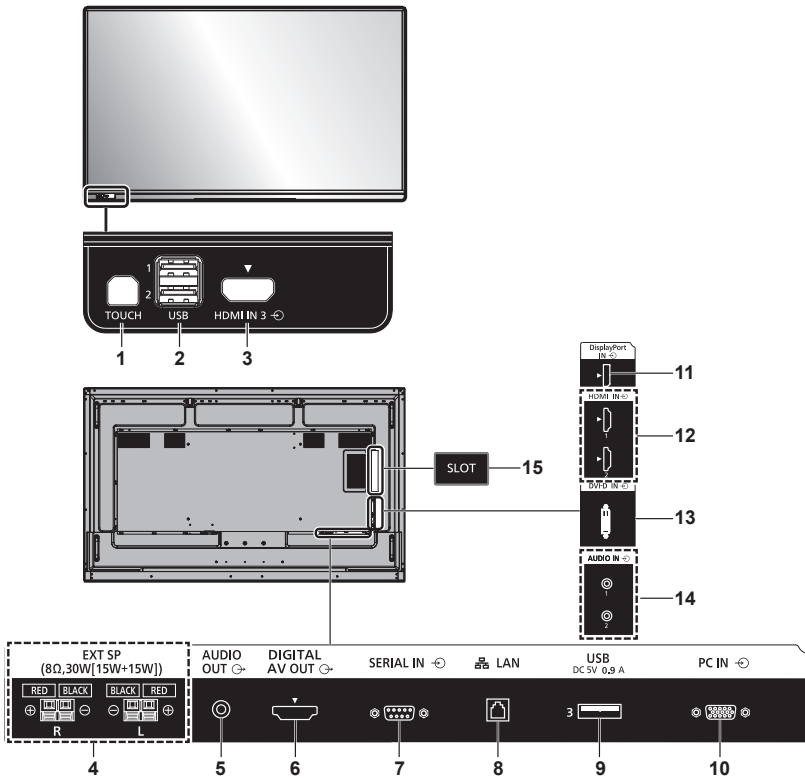

1 TOUCH (USB): It is connected to a PC for using the touch panel.

2 USB 1, USB 2: USB Terminal
Connect the USB memory to use "USB media player" or "Memory viewer". Also, this can be used to supply power of up to 5 V/0.5 A to an external device when the picture is displayed.

3 HDMI IN 3: HDMI Input Terminal
Connect to video equipment with HDMI output.

4 EXT SP: Speaker Terminal
Connect to external speaker.

5 AUDIO OUT: Analogue Audio Output Terminal
Connect to audio equipment with analogue audio input terminal.

6 DIGITAL AV OUT: Digital AV Output Terminal
Outputs video and audio signals being reproduced on the display. Connect to video equipment with HDMI input.

7 SERIAL IN: SERIAL Input Terminal
Control the Display by connecting to PC.

8 LAN: LAN Terminal
Control the Display by connecting to Network.

9 USB 3: USB Terminal
Connect the USB memory to use "USB media player" or "Memory viewer". Also, this can be used to supply power of up to 5 V/0.9 A to an external device when the picture is displayed.

10 PC IN:	PC Input Terminal Connect to video terminal of PC, video equipment with "YPbPr / YCbCr" or "RGB" output.
11 DisplayPort IN:	DisplayPort Input Terminal (Supports 4K picture) Connect to PC or video equipment with DisplayPort terminal.
12 HDMI IN 1, HDMI IN 2:	HDMI Input Terminal (2 systems) Connect to video equipment with HDMI output.
13 DVI-D IN:	DVI-D Input Terminal Connect to video equipment with DVI-D output.
14 AUDIO IN 1, AUDIO IN 2:	Analogue Audio Input Terminal (2 systems)
15 SLOT:	Expansion slot (see page 12)

Note

- For the compatible function board, consult the dealer where you purchased the product.

Before connecting

- Before connecting cables, carefully read the operating instructions for the external device to be connected.
- Turn off the power of all devices before connecting cables.
- Take note of the following points before connecting the cables. Failure to do so may result in malfunctions.
 - When connecting a cable to the unit or a device connected to the unit itself, touch any nearby metallic objects to eliminate static electricity from your body before performing work.
 - Do not use unnecessarily long cables to connect a device to the unit or to the unit body. The longer the cable, the more susceptible to noise it becomes. Since using a cable while it is wound makes it act like an antenna, it is more susceptible to noise.
 - When connecting cables, insert them straight into the connecting terminal of the connecting device so that the ground is connected first.
- Acquire any cable necessary to connect the external device to the system that is neither supplied with the device nor available as an option.
- If the outer shape of the plug of a connection cable is large, it may come in contact with the periphery such as a back cover or the plug of an adjacent connection cable. Use a connection cable with the suitable plug size for the terminal alignment.
- When connecting the LAN cable with plug cover, be aware that the cover may come in contact with the back cover and it may be difficult to disconnect.
- If video signals from video equipment contain too much jitter, the images on the screen may wobble. In this case, a time base corrector (TBC) must be connected.
- When the sync signals output from PC or video equipment are disturbed, for example, when changing settings of video output, the colour of the video may be disturbed temporarily.
- The unit accepts YPbPr/YCbCr signals (PC IN), analogue RGB signals (PC IN) and digital signals.
- Some PC models are not compatible with the unit.
- Use cable compensator when you connect devices to the unit using long cables. Otherwise the image may not be displayed properly.

Identifying Controls

Display

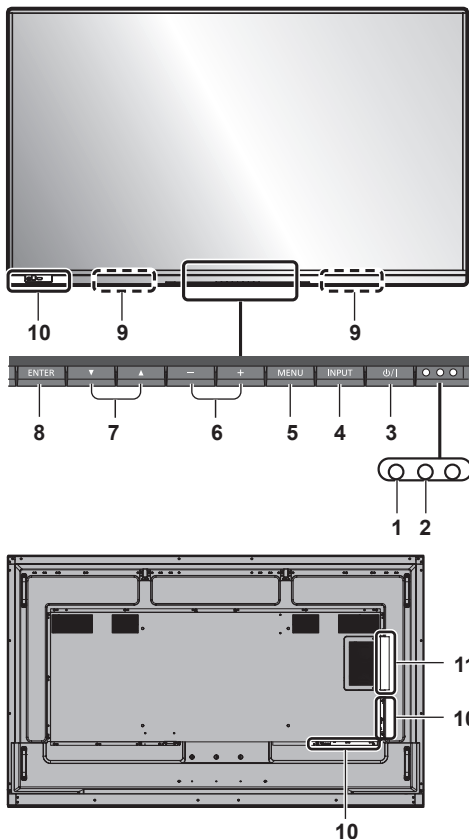

1 Power Indicator

When the power of the unit is ON (Main Power On / Off button: ON)

- Picture is displayed: blue
- When the unit enters the standby mode using the following functions: purple
 - Standby state with [Power on settings] - [Quick start] set to [On]
 - Standby state with the "Power management" function
 - Standby state with [HDMI-CEC control] set to [Enable] and at least one [Link function] set to other than [Disable]
 - Standby state with [Network control] set to [On]
 - Standby state during schedule play mode
- Standby state in conditions other than the above: orange

When the power of the unit is OFF (Main Power On / Off button: OFF): No light

Note

- Even if the unit is turned off with the power indicator off, some of the circuits are in power-on status.
- When the power indicator is purple, power consumption during standby is generally larger than that of when the power indicator is orange.
- Considering COLOR UNIVERSAL DESIGN, purple lights up brighter than blue.

2 Remote control sensor

3 <Main Power On / Off button> (⏻/⏻)

Turns the power On / Off.

4 <INPUT (Unit)>

Selects the connected device.

5 <MENU (Unit)>

Displays the menu screen.

6 <+ (Unit)> / <- (Unit)>

Adjusts the volume.

On the main screen, switches settings or adjusts settings level.

7 <▲ (Unit)> / <▼ (Unit)>

Selects the setting item on menu screen.

8 <ENTER (Unit)>

Configures the item on menu screen.

Switches aspect mode.

9 Built-in speakers

Sound is output backward.

Note

- To output sound from the built-in speakers of the unit, be sure to set [Sound] - [Output select] to [INTERNAL SPEAKERS].

10 External input / output terminal

Connects to video equipment, PC, etc. (see page 17)

11 Expansion slot (see page 12)

■ Storage the pens and eraser

The supplied pens and eraser can be stored at the location shown below.

Storage location for pens and eraser

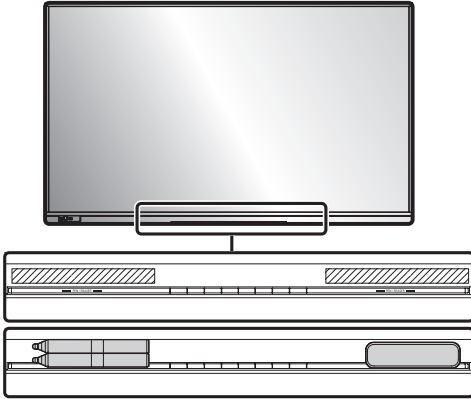

The pens and eraser can be put on either right or left side.

Remote Control Transmitter

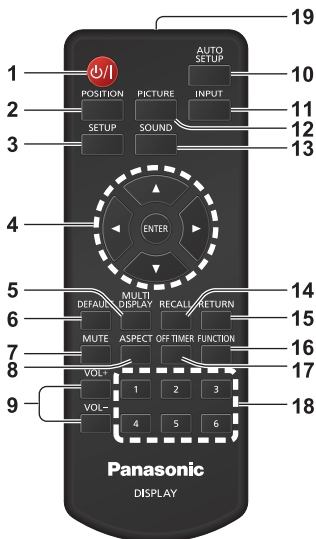

1 Standby (ON/OFF) button (⏻/⏻)

- Turns the power on or off when the unit is turned on at the <Main Power On / Off button>. (see page 22)

2 POSITION

3 SETUP

4 ENTER / Cursor buttons (▲▼◀▶)

- Used to operate the menu screens.

5 MULTI DISPLAY

- Switches between on and off of the multi display mode (multi input display).

6 DEFAULT

- Resets the settings of picture, sound, etc., to defaults.

7 MUTE

- Sound mute on / off.

8 ASPECT

- Adjusts the aspect.

9 VOL + / VOL -

- Adjusts sound volume level.

10 AUTO SETUP

- Automatically adjusts the position/size of the screen.

11 INPUT

- Switches input to display on the screen.

12 PICTURE

13 SOUND

14 RECALL

- Displays the current setting status of Input mode, Aspect mode, etc.

15 RETURN

- Used to return to the previous menu.

16 FUNCTION

- Displays [Function button guide].

17 OFF TIMER

- Switches to stand-by after a fixed period.

18 Numeric buttons (1 - 6)

- Used as shortcut buttons by assigning frequently used operations.

19 Signal emission

Note

- In this manual, buttons of the remote control and the unit are indicated as < >.

(Example: <INPUT>.)

The operation is mainly explained indicating the remote control buttons but you can also operate with the buttons on the unit when there are the same buttons.

Basic Controls

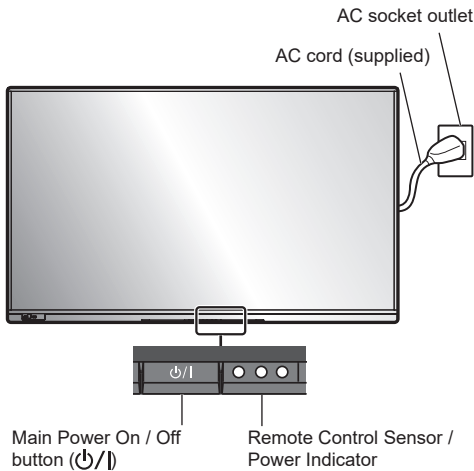

Operate pointing the remote control directly at the unit's Remote Control Sensor.

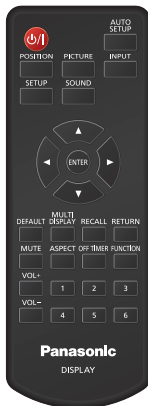

Note

- Do not put an obstacle between the remote control sensor of the main unit and the remote control.
- Operate the remote control in front of the remote control sensor or from the area where the sensor can be seen.
- When directly aiming the remote control at the remote control sensor of the main unit, the distance from the front of remote control sensor should be approx. 7 m or less. Depending on the angle, the operation distance may be shorter.
- Do not subject the remote control sensor of the main unit to the direct sunlight or strong fluorescent light.

1 Connect the AC cord plug to the Display.

(see page 15)

2 Connect the plug to the socket outlet.

Note

- When disconnecting the AC cord, be absolutely sure to disconnect the AC cord plug at the socket outlet first.
- The settings may not be saved if the power plug is disconnected immediately after changing settings with on-screen menu. Disconnect the power plug after a enough period of time. Or, disconnect the power plug after turning the power off with the remote control, RS-232C control or LAN control.

3 Press the <Main Power On / Off button> (⏻/⏻) on the unit to turn the power of the unit on.

- Power Indicator: Blue (Picture is displayed.)
- When the power of the unit is on, the power indicator lights up and remote control operation is possible.
- When the power indicator is lit, it is not necessary to press the <Main Power On / Off button> (⏻/⏻) on the unit. Operate the remote control so that the power indicator turns blue (picture is displayed).

■ To turn the power ON/OFF with the remote control

To turn the power on

- When the power of the unit is on (Power Indicator - orange or purple), press the <Standby (ON/OFF) button> (⏻/⏻), then the picture will be displayed.
- Power Indicator: Blue (Picture is displayed.)

To turn the power off

- When the power of the unit is on (Power Indicator - blue), press the <Standby (ON/OFF) button> (⏻/⏻), then the power will be turned off.
- Power Indicator: Orange (standby)

Note

- During operation of the “Power management” function, the power indicator turns purple in the power off state.
- After the power plug is disconnected, the power indicator may remain lit for a while. This is not a malfunction.
- Press the <Main Power On / Off button> (⏻/⏻) on the unit to turn the unit off, when the power of the unit is turned on or in standby mode.

■ When the Unit is turned on for the first time

Following screen will be displayed.

Select the language with ▲ ▼ and press <ENTER>.



Note

- Once the item is set, this screen won't be displayed when switching on the unit next time.
Use the following menu to configure the setting again.
[OSD language]

After [OSD language] is set, the following screen is displayed.

Configure the network account setting as necessary.

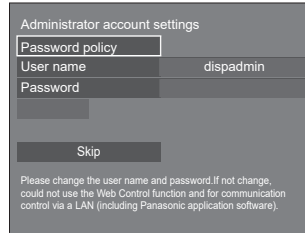

Password policy

Cautions regarding the password setting in this item are displayed on another window.

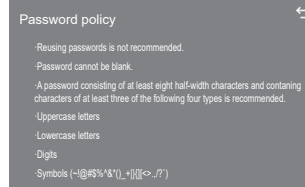

User name

A keyboard for user name setting is displayed. Enter the user name.

Password

A keyboard for password setting is displayed. After the password is entered, select [OK] to display a confirmation screen. Enter the password again and select [OK] to determine the password.

Save

The user name and password set above are saved in the display unit.

Skip

Exits this screen without configuring this setting.

Note

- Once set or skipped, this screen won't be displayed when switching on the unit next time. Use the following menu to configure the setting again.
[Network settings]

■ Power ON message

The following message may be displayed when turning the unit power ON:

No activity power off Precautions

'No activity power off' is enabled.

When [No activity power off] in the [Setup] menu is set to [Enable], a warning message is displayed every time the power is turned ON.

"Power management" information

Last turn off due to 'Power management'.

When "Power management" is functioned, an information message is displayed every time the power is turned ON.

Display reverse installation information

The display is upside-down.

When it is judged that the display is reversely installed, an information message is displayed when the power is turned ON.

These message displays can be set with the following menus:

- [Power on settings] menu
 - Information(No activity power off)
 - Information(Power management)
 - Information(Display upside-down)

COLOR UNIVERSAL DESIGN Information

'Color universal design' is enabled.

The information is displayed when [Setup] - [Color universal design settings] - [Color universal design] is set to [On].

Specifications

Model No.

75-inch model): TH-75BQ1W

65-inch model): TH-65BQ1W

Power Consumption

75-inch model

363 W

65-inch model

320 W

Power off condition

0.3 W

Stand-by condition

0.5 W

LCD Display panel

75-inch model

Direct LED backlight, 16:9 aspect ratio

65-inch model

Direct LED backlight, 16:9 aspect ratio

Screen size

75-inch model

1 649.6 mm (W) × 927.9 mm (H) × 1 892.7 mm
(diagonal) / 64.94" (W) × 36.53" (H) × 74.51"
(diagonal)

65-inch model

1 428.4 mm (W) × 803.5 mm (H) × 1 638.9 mm
(diagonal) / 56.23" (W) × 31.63" (H) × 64.52"
(diagonal)

No. of pixels

8 294 400

(3 840 (Horizontal) × 2 160 (Vertical))

Dimensions (W × H × D)

75-inch model

1 716 mm × 1 032 mm × 107 mm
(excluding handles: 81 mm) /
67.6" × 40.7" × 4.2"
(excluding handles: 3.2")

65-inch model

1 495 mm × 908 mm × 105 mm
(excluding handles: 81 mm) /
58.9" × 35.8" × 4.2"
(excluding handles: 3.2")

Mass

75-inch model

Approx. 56.6 kg / 124.8 lbs net

65-inch model

Approx. 43.4 kg / 95.7 lbs net

Power source

110 – 240 V ~ (110 – 240 V alternating current),
50/60 Hz

Operating condition

Temperature

0 °C – 40 °C (32 °F – 104 °F)*1

Humidity

20 % – 80 % (no condensation)

Operating Time

18 hours/day

Supply power for SLOT

3.3 V/max 1.1 A, 12 V/max 5.5 A

Connection terminals

HDMI IN 1

HDMI IN 2

HDMI IN 3

TYPE A Connector*2 × 3 (Supports 4K)

Compatible with HDCP 2.2

Audio signal:

Linear PCM (sampling frequencies: 48 kHz,
44.1 kHz, 32 kHz)

DisplayPort IN

DisplayPort Terminal × 1

Compatible with HDCP 2.2

Audio signal:

Linear PCM (sampling frequencies: 48 kHz,
44.1 kHz, 32 kHz)

DVI-D IN

DVI-D 24 Pin × 1:

Compliance with DVI Revision 1.0

Compatible with HDCP 1.1

PC IN

Mini D-sub 15 Pin (Compatible with DDC2B) × 1

Y/G:

1.0 V_{p-p} (75 Ω) (with sync signal)

0.7 V_{p-p} (75 Ω) (without sync signal)

P_B/C_B/B:

0.7 V_{p-p} (75 Ω) (without sync signal)

P_R/C_R/R:

0.7 V_{p-p} (75 Ω) (without sync signal)

HD/VD:

TTL (high impedance)

DIGITAL AV OUT

HDMI TYPE A Connector × 1 (Supports 4K)

Linear PCM (sampling frequencies: 48 kHz)

AUDIO IN 1

AUDIO IN 2

Stereo mini jack (M3) × 2, 0.5 V_{rms}

AUDIO OUT

Stereo mini jack (M3) × 1, 0.5 V_{rms}

Output: Variable (-∞ – 0 dB)

(1 kHz 0 dB input, 10 kΩ load)

SERIAL IN

External Control Terminal

D-sub 9 Pin × 1:

RS-232C compatible

LAN

RJ45 × 1:

For network connection, compatible with PLink

Communication method:

RJ45, 10BASE-T / 100BASE-TX / 1000BASE-T

USB

USB connector × 3, TYPE A (front × 2, rear × 1)

DC 5 V/max 500 mA (front side terminal),

DC 5 V/max 900 mA (rear side terminal)

USB connector × 1,

TYPE B (front × 1, for touch module)

EXT SP

8 Ω, 30 W [15 W + 15 W] (10 % THD)

Sound

Speakers

90 mm × 25 mm × 1 / φ 20 mm × 1 × 2 pieces

Audio Output

20 W [10 W + 10 W] (10 % THD)

Remote Control Transmitter

Power source

DC 3 V (battery (AAA/R03/LR03 type) × 2)

Operating range

Approx. 7 m (22.9 ft)

(when operated directly in front of remote control sensor)

Mass

Approx. 63 g / 2.22 oz (including batteries)

Dimensions (W × H × D)

48 mm × 134 mm × 20 mm / 1.89" × 5.28" × 0.76"

*1: Environmental temperature to use this unit at high altitudes (1 400 m (4 593 ft) and higher and below 2 800 m (9 186 ft) above sea level): 0 °C to 35 °C (32 °F to 95 °F)

*2: VIERA LINK is not supported.

Note

- Design and specifications are subject to change without notice. Mass and dimensions shown are approximate.

Software License

This product incorporates the following software:

- (1) the software developed independently by or for Panasonic Connect Co., Ltd.,
- (2) the software owned by third party and licensed to Panasonic Connect Co., Ltd.,
- (3) the software licensed under the GNU General Public License, Version 2.0 (GPL V2.0),
- (4) the software licensed under the GNU LESSER General Public License, Version 2.0 (LGPL V2.0),
- (5) the software licensed under the GNU LESSER General Public License, Version 2.1 (LGPL V2.1), and/or
- (6) open source software other than the software licensed under the GPL V2.0, LGPL V2.0 and/or LGPL V2.1.

The software categorized as (3) - (6) are distributed in the hope that it will be useful, but WITHOUT ANY WARRANTY, without even the implied warranty of MERCHANTABILITY or FITNESS FOR A PARTICULAR PURPOSE. For details, see the license conditions displayed by selecting [Software licenses], following the specified operation from the [Setup] menu of this product.

At least three (3) years from delivery of this product, Panasonic Connect Co., Ltd. will give to any third party who contacts us at the contact information provided below, for a charge no more than our cost of physically performing source code distribution, a complete machine-readable copy of the corresponding source code covered under GPL V2.0, LGPL V2.0, LGPL V2.1 or the other licenses with the obligation to do so, as well as the respective copyright notice thereof.

Contact Information:

oss-cd-request@gg.jp.panasonic.com

Notice about AVC/VC-1/MPEG-4

This product is licensed under the AVC Patent Portfolio License, VC-1 Patent Portfolio License and MPEG-4 Visual Patent Portfolio License for the personal use of a consumer or other uses in which it does not receive remuneration to (i) encode video in compliance with the AVC Standard, VC-1 Standard and MPEG-4 Visual Standard ("AVC/VC-1/MPEG-4 Video") and/or (ii) decode AVC/VC-1/MPEG-4 Video that was encoded by a consumer engaged in a personal activity and/or was obtained from a video provider licensed to provide AVC/VC-1/MPEG-4 Video. No license is granted or shall be implied for any other use. Additional information may be obtained from MPEG LA, LLC. See <http://www.mpegla.com>.

**PANASONIC PROFESSIONAL DISPLAY
 Limited Warranty**

Models or Parts	Part Warranty	Labor Warranty
All Professional Display Model	3 Years	3 Years
Exceptions		
All Panasonic accessories: e.g. mounting kit, input signal module, cables, remote control, filter, batteries.	1 Year	1 Year

Panasonic Connect North America (referred to as “the Panasonic”) will repair the Professional Video product (the “Product”) and its accessories as defined in the attached table, with new or refurbished parts, free of charge in the continental USA, during the applicable warranty coverage period from the original date of purchase in the event of a defect in materials or workmanship as follows: On-Site, carry-in, or mail-in service within the **continental USA** may be obtained during the warranty period by contacting Panasonic’s Technical Support Center at the following toll free number **855-772-8324** or via

e-mail: ProDisplaySupport@us.panasonic.com. In case of mail-in service the customer is responsible for the cost of delivering of the Product to Panasonic’s facility, while Panasonic will pay for the return transportation of the repaired Product to the customer. For out of warranty Product units submitted for repairs or for in warranty units submitted by customers outside of the continental USA, shipping arrangements and cost (both ways) are the customer’s responsibility. Panasonic will also not be responsible for any costs associated with determining the source of system problems or for removing and installing the faulty Product.

This warranty is extended only to the original purchaser and is nontransferable. A purchase receipt or other proof of date of original purchase will be required before warranty service is rendered. Whenever the date of original purchase cannot be satisfactorily determined, the date of manufacture of the unit will be deemed to be the effective date of the warranty. Panasonic reserves the right to audit and reject any warranty claim that cannot be substantiated. This warranty only covers failures due to defects in materials or workmanship which occur during normal use of the Product.

The warranty **DOES NOT** cover damage to the display and its components which occur in shipping; failures which are caused by products not supplied by Panasonic; failures which result from accident, misuse, abuse, neglect, mishandling, misapplication, alteration, modification, faulty installation, setup adjustments, improper antenna, inadequate signal pickup, maladjustment of user controls, improper operation, power line surge, improper voltage supply, lightning damage, smoke or chemical vapors contamination, air conditioning, humidity control or other environmental conditions; failure to maintain the product in accordance with the applicable Operating Instructions; service by anyone other than an authorized repair facility; damage that is attributable to acts of violence, war, acts of God or force majeure.

The warranty does not cover damage which occurs to the display or its components caused by excessive continual usage which goes beyond the operational time described in the Operating Instructions. The warranty does not cover units of which the model and serial number label has been defaced, modified, tampered with or removed. The warranty does not cover consumable parts.

LIMITS AND EXCLUSIONS

PANASONIC SHALL NOT BE LIABLE FOR ANY INDIRECT, INCIDENTAL, CONSEQUENTIAL, PUNITIVE OR SPECIAL DAMAGES, INCLUDING, BUT NOT LIMITED TO, LOSS OF DATA, LOSS OF PROFIT, LOSS OF REVENUE, OR LOSS OF BUSINESS OR GOODWILL, SUFFERED BY ANY PERSON, AND RESULTING FROM THE USE OF THIS PANASONIC PROFESSIONAL DISPLAY PRODUCT, OR ARISING OUT OF ANY BREACH OF THIS WARRANTY. ALL EXPRESS WARRANTIES SPECIFIED ABOVE ARE IN LIEU OF ALL OTHER WARRANTIES, EXPRESS, IMPLIED OR STATUTORY, INCLUDING BUT NOT LIMITED TO, THE IMPLIED WARRANTIES OF MERCHANTABILITY AND FITNESS FOR A PARTICULAR PURPOSE. Some states do not allow the exclusion or limitation of incidental or consequential damages, or limitations on how long an implied warranty lasts, so the above limitations or exclusions may not apply to you.

If you have a problem with this product that is not handled to your satisfaction, then write the Consumer Affairs Department at the Panasonic’s address indicated above.

Panasonic Canada Inc.
5770 Ambler Drive, Mississauga, Ontario L4W 2T3
LIMITED WARRANTY STATEMENT

Panasonic Canada Inc. (also known as PCI) warrants this product to be free of defects in material and workmanship under normal use during the applicable warranty coverage period described below. PCI agrees to repair, or at its option, exchange any part that becomes defective. However, the product must be purchased and serviced in Canada. The product or part that shows evidence of defect must be delivered prepaid or carried in to an authorized Panasonic Broadcast Service Center. This warranty does not cover shipping costs.

The warranty coverage period is one year for both parts and labour beginning with the date of original end user purchase, subject to the exceptions as stated below. Repaired or replacement parts supplied during the warranty coverage period carry the unexpired portion of the original warranty coverage period. Proof of product purchase is a condition of warranty service. The owner must produce the product purchase receipt or other satisfactory evidence of date of original purchase.

This warranty does not apply to external appearance items, such as handles, knobs, switches, buttons, etc. This warranty does not apply to accessories of the product, installed, altered, repaired or misused, or to any part, in the opinion of PCI, effects the reliability of or detracts from the performance of the product.

For products requiring routine preventive maintenance, that maintenance must be performed in order to maintain warranty coverage.

Serial numbers that have been altered, defaced or removed void this warranty. This warranty does not cover replacements or repairs necessitated by loss or damage resulting from any cause beyond the control of PCI.

Marking or related images (sometimes called "burn-in") resulting from the display of fixed images on video display products are not defects and are not covered under this warranty.

THIS EXPRESS, LIMITED WARRANTY IS IN LIEU OF ALL OTHER WARRANTIES, EXPRESS OR IMPLIED, INCLUDING ANY IMPLIED WARRANTIES OF MERCHANTABILITY AND FITNESS FOR A PARTICULAR PURPOSE. IN NO EVENT WILL PANASONIC CANADA INC. BE LIABLE FOR ANY SPECIAL, INDIRECT OR CONSEQUENTIAL DAMAGES.

In certain instances, some jurisdictions do not allow the exclusion or limitation of incidental or consequential damages, or the exclusion of implied warranties, so the above limitations and exclusions may not be applicable.

WARRANTY COVERAGE PERIOD EXCEPTIONS

Item	Parts	Labour
Video Tape	30 days—Replacement only (Content not covered)	N/A
P2/SD Cards	(Content not covered)	N/A
Video Heads	1 year or 2,000 hrs. (priorated) whichever comes first	1 year or 2,000 hrs. whichever comes first
D5 Video heads	1 year or 1,000 hrs. whichever comes first	1 year or 1,000 hrs. whichever comes first
Maintenance Items	2 years	2 years
Colour Camera CCD Imaging Block	2 years	2 years
All LCD Monitors	2 years (burn-in not covered)	2 years
*DLP™ Projectors	3 years or 17,000 hrs. whichever comes first	3 years or 17,000 hrs. whichever comes first
1 LCD Projectors above	3 years or 2,500 hrs. whichever comes first	3 years or 2,500 hrs. whichever comes first
*LCD Projectors below	3 years or 1,500 hrs. whichever comes first	3 years or 1,500 hrs. whichever comes first
2,500 ANSI Lumens Projector Lamps	50% of the rated lamp life or 1 year. Whichever comes first	50% of the rated lamp life or 1 year. Whichever comes first
All Plasma displays	2 years (burn-in not covered)	2 years
103 inch Plasma displays	3 years (burn-in not covered)	3 years
Hard Drive Disk Unit	1 year plus balance (if any) of the original Manufacturer's Limited Warranty. (Content not covered)	1 year

* Dust, smoke, rental/staging environment and twenty-four/seven operation, dramatically decreases the interval between performances of routine preventive maintenance required to maintain this warranty coverage.

Warranty Service

If the product needs to be shipped for service, carefully pack (preferably in the original carton) and enclose a letter, detailing the complaint. Send prepaid and adequately insured to the local authorized Panasonic Service Centre in your area or to Panasonic Technical Support and Product Services Department, 5770 Ambler Drive, Mississauga, Ontario, L4W 2T3. Shipping to the latter location requires a return authorization before shipment. NO liability is assumed for loss or damage to the product while in transit.

Notice (U.S.A. only)

Disposal may be regulated in your community due to environmental considerations. For disposal or recycling information, please visit Panasonic website:

<https://holdings.panasonic/global/corporate/sustainability.html>

or call 1-888-769-0149.

Customer's Record

The model number and serial number of this product may be found on its rear panel. You should note this serial number in the space provided below and retain this book, plus your purchase receipt, as a permanent record of your purchase to aid in identification in the event of theft or loss, and for Warranty Service purposes.

Model Number

Serial Number

Panasonic Connect North America

Unit of Panasonic Corporation of North America

Executive Office :

Two Riverfront Plaza, Newark, New Jersey 07102

Panasonic Canada Inc.

5770 Ambler Drive, Mississauga, Ontario L4W 2T3

Panasonic Connect Co., Ltd.

4-1-62 Minoshima, Hakata-ku, Fukuoka 812-8531, Japan

Web Site: <https://panasonic.net/cns/prodisplays/>

© Panasonic Connect Co., Ltd. 2022

English

Printed in China