

Panasonic®

Operating Instructions Basic Guide

Touch screen LCD display For business use

English

Model No. **TH-75BQE1W** 75-inch model

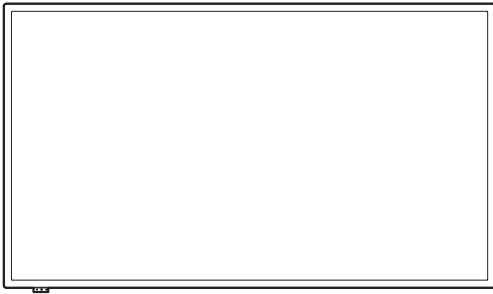

Contents

Important Safety Instructions	2
FCC STATEMENT	3
Important Safety Notice	4
Safety Precautions	5
Precautions for use	9
Introduction	11
Installation	17
Operation	21
Specifications	23
PANASONIC PROFESSIONAL DISPLAY Limited Warranty	25
LIMITED WARRANTY STATEMENT	26
Customer Service	27

For more detailed instructions, refer to the
Operating Instructions on the CD-ROM.

- Please read these instructions before operating your set and retain them for future reference.
- Illustrations and screens in this Operating Instructions are images for illustration purposes, and may be different from the actual ones.

4K
PROFESSIONAL
*Actual resolution: 3840 × 2160p

HDMI™

DOLBY AUDIO™



Important Safety Instructions



WARNING
RISK OF ELECTRIC SHOCK
DO NOT OPEN



WARNING: To reduce the risk of electric shock, do not remove cover or back.

No user-serviceable parts inside. Refer servicing to qualified service personnel.



The lightning flash with arrow-head within a triangle is intended to tell the user that parts inside the product are a risk of electric shock to persons.



The exclamation point within a triangle is intended to tell the user that important operating and servicing instructions are in the papers with the appliance.

WARNING:

To prevent damage which may result in fire or shock hazard, do not expose this apparatus to rain or moisture.

**Do not place containers with water (flower vase, cups, cosmetics, etc.) above the set.
(including on shelves above, etc.)**

WARNING:

- 1) To prevent electric shock, do not remove cover. No user serviceable parts inside. Refer servicing to qualified service personnel.
- 2) Do not remove the grounding pin on the power plug. This apparatus is equipped with a three pin grounding-type power plug. This plug will only fit a grounding-type power outlet. This is a safety feature. If you are unable to insert the plug into the outlet, contact an electrician.
Do not defeat the purpose of the grounding plug.

- 1) Read these instructions.
- 2) Keep these instructions.
- 3) Heed all warnings.
- 4) Follow all instructions.
- 5) Do not use this apparatus near water.
- 6) Clean only with dry cloth.
- 7) Do not block any ventilation openings. Install in accordance with the manufacturer's instructions.
- 8) Do not install near any heat sources such as radiators, heat registers, stoves, or other apparatus (including amplifiers) that produce heat.
- 9) Do not defeat the safety purpose of the polarized or grounding-type plug. A polarized plug has two blades with one wider than the other. A grounding type plug has two blades and a third grounding prong. The wide blade or the third prong are provided for your safety. If the provided plug does not fit into your outlet, consult an electrician for replacement of the obsolete outlet.
- 10) Protect the power cord from being walked on or pinched particularly at plugs, convenience receptacles, and the point where they exit from the apparatus.
- 11) Only use attachments / accessories specified by the manufacturer.
- 12) Use only with the cart, stand, tripod, bracket, or table specified by the manufacturer, or sold with the apparatus. When a cart is used, use caution when moving the cart / apparatus combination to avoid injury from tip-over. 
- 13) Unplug this apparatus during lightning storms or when unused for long periods of time.
- 14) Refer all servicing to qualified service personnel. Servicing is required when the apparatus has been damaged in any way, such as power-supply cord or plug is damaged, liquid has been spilled or objects have fallen into the apparatus, the apparatus has been exposed to rain or moisture, does not operate normally, or has been dropped.
- 15) To prevent electric shock, ensure the grounding pin on the AC cord power plug is securely connected.

FCC STATEMENT

This equipment has been tested and found to comply with the limits for a class A digital device, pursuant to Part 15 of the FCC Rules. These limits are designed to provide reasonable protection against harmful interference when the equipment is operated in a commercial environment. This equipment generates, uses and can radiate radio frequency energy and, if not installed and used in accordance with the instructions manual, may cause harmful interference to radio communications. Operation of this equipment in a residential area is likely to cause harmful interference in which case the user will be required to correct the interference at his own expense.

FCC CAUTION:

To assure continued compliance, follow the attached installation instructions and use only the provided power supply cord. Any changes or modifications not expressly approved by Panasonic Corp. of North America could void the user's authority to operate this device.

Declaration of Verification

Model No.

TH-75BQE1W

Responsible Party:

Panasonic Corporation of North America
Two Riverfront Plaza, Newark, New Jersey
07102-5490

Contact Source:

Panasonic System Solutions Company of North America
1-877-655-2357

General Contact:

<http://shop.panasonic.com/support>

This device complies with Part 15 of the FCC Rules and all applicable IC RSS standards. Operation is subject to the following two conditions: (1) This device may not cause harmful interference, and (2) this device must accept any interference received, including interference that may cause undesired operation.

CANADIAN NOTICE:

This Class A digital apparatus complies with Canadian ICES-003.

WARNING:

- Not for use in a computer room as defined in the Standard for the Protection of Electronic Computer/ Data Processing Equipment, ANSI/NFPA 75.
- For permanently connected equipment, a readily accessible disconnect device shall be incorporated in the building installation wiring.
- For pluggable equipment, the socket-outlet shall be installed near the equipment and shall be easily accessible.

Note:

Image retention may occur. If you display a still picture for an extended period, the image might remain on the screen. However, it will disappear when a general moving picture is displayed for a while.

Trademark Credits

- Microsoft, Windows and Internet Explorer are the registered trademarks or trademarks of Microsoft Corporation in the United States and/or other countries.
- Macintosh, Mac, Mac OS, OS X and Safari are the trademarks of Apple Inc. registered in the United States and other countries.
- HDMI, High-Definition Multimedia Interface and the HDMI Logo are trademarks or registered trademarks of HDMI Licensing Administrator, Inc. in the United States and other countries.
- Manufactured under license from Dolby Laboratories. Dolby and the double-D symbol are trademarks of Dolby Laboratories.

Even if no special notation has been made of company or product trademarks, these trademarks have been fully respected.

Important Safety Notice

WARNING

- 1) To prevent damage which may result in fire or shock hazard, do not expose this appliance to dripping or splashing.
Do not place containers with water (flower vase, cups, cosmetics, etc.) above the set. (including on shelves above, etc.)
No naked flame sources, such as lighted candles, should be placed on / above the set.
- 2) To prevent electric shock, do not remove cover. No user serviceable parts inside. Refer servicing to qualified service personnel.
- 3) Do not remove the earthing pin on the power plug. This apparatus is equipped with a three pin earthing-type power plug. This plug will only fit an earthing-type power outlet. This is a safety feature. If you are unable to insert the plug into the outlet, contact an electrician.
Do not defeat the purpose of the earthing plug.
- 4) To prevent electric shock, ensure the earthing pin on the AC cord power plug is securely connected.

CAUTION

This appliance is intended for use in environments which are relatively free of electromagnetic fields.

Using this appliance near sources of strong electromagnetic fields or where electrical noise may overlap with the input signals could cause the picture and sound to wobble or cause interference such as noise to appear.

To avoid the possibility of harm to this appliance, keep it away from sources of strong electromagnetic fields.

WARNING:

This equipment is compliant with Class A of CISPR32. In a residential environment this equipment may cause radio interference.

IMPORTANT INFORMATION

If a display is not positioned in a sufficiently stable location, it can be potentially hazardous due to falling. Many injuries, particularly to children, can be avoided by taking simple precautions such as:

- Using cabinets or stands recommended by the manufacturer of the display.
- Only using furniture that can safely support the display.
- Ensuring the display is not overhanging the edge of the supporting furniture.
- Not placing the display on tall furniture (for example, cupboards or bookcases) without anchoring both the furniture and the display to a suitable support.
- Not standing the displays on cloth or other materials placed between the display and supporting furniture.
- Educating children about the dangers of climbing on furniture to reach the display or its controls.

**IMPORTANT: THE MOULDED PLUG
FOR YOUR SAFETY, PLEASE READ THE
FOLLOWING TEXT CAREFULLY.**

This display is supplied with a moulded three pin mains plug for your safety and convenience. A 10 amp fuse is fitted in this plug. Shall the fuse need to be replaced, please ensure that the replacement fuse has a rating of 10 amps and that it is approved by ASTA or BSI to BS1362.

Check for the ASTA mark  or the BSI mark  on the body of the fuse.

If the plug contains a removable fuse cover, you must ensure that it is refitted when the fuse is replaced.

If you lose the fuse cover the plug must not be used until a replacement cover is obtained.

A replacement fuse cover can be purchased from your local Panasonic dealer.
Do not cut off the mains plug.

Do not use any other type of mains lead except the one supplied with this display.

The supplied mains lead and moulded plug are designed to be used with this display to avoid interference and for your safety.

If the socket outlet in your home is not suitable, get it changed by a qualified electrician.

If the plug or mains lead becomes damaged, purchase a replacement from an authorized dealer.

WARNING : — THIS DISPLAY MUST BE EARTHED.

How to replace the fuse.

Open the fuse compartment with a screwdriver and replace the fuse.

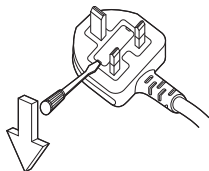

Safety Precautions

WARNING

■ Setup

This LCD Display is for use only with the following optional accessory.

Use with any other type of optional accessories may cause instability which could result in the possibility of injury.

(The following accessory is manufactured by Panasonic Corporation.)

Please firmly install the Pedestal sold separately. Installation should be done by a professional vendor.

Work in a team of 4 persons when installing.

Pedestal

- TY-ST75PE9

Note

- When installing the Pedestal, thoroughly read the instructions manual included with the product and correctly install the stand. Make sure to take the fall-prevention measures.
- For ensuring safety and performance, ask your distributor or a professional vendor to carry out the installation work.
- Please note that we will not be responsible for any product damage that happens due to defects in the installation environment of stand or wall-mounting clasp even if it is within the warranty period.
- For the products that you are no longer using, ask a professional contractor to promptly remove such products.
- When installing, "crack in LCD panel" may occur because of impact etc. Therefore, please carefully handle the product.
- The part numbers of optional items are subject to change without notice.

We are not responsible for any product damage, etc. caused by failures in the installation environment even during the warranty period.

Always be sure to ask a qualified technician to carry out set-up.

Small parts can present choking hazard if accidentally swallowed. Keep small parts away from young children. Discard unneeded small parts and other objects, including packaging materials and plastic bags/sheets to prevent them from being played with by young children, creating the potential risk of suffocation.

Do not place the Display on sloped or unstable surfaces, and ensure that the Display does not hang over the edge of the base.

- The Display may fall off or tip over.

Install this unit at a location with minimal vibration and which can support the weight of the unit.

- Dropping or falling of the unit may cause injury or malfunction.

Do not place any objects on top of the Display.

- If foreign objects or water get inside the Display, a short-circuit may occur which could result in fire or electric shock. If any foreign objects get inside the Display, please consult your local Panasonic dealer.

Transport only in upright position!

- Transporting the unit with its front panel facing upright or downward may cause damage to the internal circuitry.

Ventilation should not be impeded by covering the ventilation openings with items such as newspapers, table cloths and curtains.

For sufficient ventilation, see page 9.

Caution - For use only with UL Listed Wall Mount Bracket with minimum weight/load 68.0 kg (150.0 lbs).

When installing the Display vertically;

When installing the Display vertically, be sure that the Power Indicator comes to the downside. Heat is generated and it may cause fire or damage to the Display.

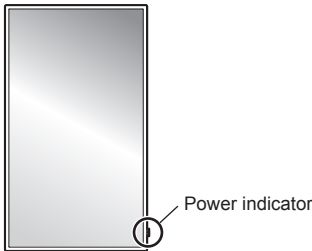

Cautions for Wall or Pedestal Installation

- The installation should be performed by an installation professional. Installing the Display incorrectly may lead to an accident that results in death or serious injury. Use the optional Pedestal. (see page 5)
- When installing on a wall, a wall hanging bracket that conforms to VESA standards must be used.
75-inch model : VESA 400 × 400
(see page 9)

- Before installation, be sure to check if the mounting location has enough strength to support the weight of the LCD display and the wall hanging bracket for anti drop.
- If you terminate the use of the Display on the Wall or Pedestal, ask a professional to remove the Display as soon as possible.
- When mounting the Display on the wall, prevent the mounting screws and power cable from contacting metal objects inside the wall. An electric shock may occur if they contact metal objects inside the wall.

Do not install the product to a place where the product is exposed to direct sunlight.

- If the unit is exposed to direct sunlight even indoors, the temperature rise of the liquid crystal panel may cause malfunction.

■ When using the LCD Display

The Display is designed to operate on 110 – 240 V AC, 50/60 Hz.

Do not cover the ventilation holes.

- Doing so may cause the Display to overheat, which can cause fire or damage to the Display.

Do not stick any foreign objects into the Display.

- Do not insert any metal or flammable objects into the ventilations holes or drop them onto the Display, as doing so can cause fire or electric shock.

Do not remove the cover or modify it in any way.

- High voltages which can cause severe electric shocks are present inside the Display. For any inspection, adjustment and repair work, please contact your local Panasonic dealer.

Ensure that the mains plug is easily accessible.

The mains plug shall be connected to a mains socket outlet with a protective earthing connection.

Do not use any power supply cord other than that provided with this unit.

- Doing so may cause short-circuit, generates heat, etc., which could cause electric shock or fire.

Do not use the supplied power supply cord with any other devices.

- Doing so could cause electric shock or fire.

Securely insert the power supply plug as far as it will go.

- If the plug is not fully inserted, heat may be generated which could cause fire. If the plug is damaged or the wall socket is loose, they shall not be used.

Do not handle the power supply plug with wet hands.

- Doing so may cause electric shocks.

Do not do anything that may damage the power cable. When disconnecting the power cable, pull on the plug body, not the cable.

- Do not damage the cable, make any modifications to it, place heavy objects on top of it, heat it, place it near any hot objects, twist it, bend it excessively or pull it. To do so may cause fire and electric shock. If the power cable is damaged, have it repaired at your local Panasonic dealer.

Do not touch the power supply cord or the plug directly by hand when they are damaged.

- Electric shock could occur.

Do not remove covers and NEVER modify the Display yourself.

- Do not remove the rear cover as live parts are accessible when it is removed. There are no user serviceable parts inside. (High-voltage components may cause serious electrical shock.)
- Have the Display checked, adjusted, or repaired at your local Panasonic dealer.

Keep the screws (supplied) out of reach of children. If accidentally swallowed, it will be harmful to the body.

- Please contact a doctor immediately in case you doubt that the child may have swallowed it.

When using the unit in an area where there are passers-by, do not connect the USB cable for the touch panel to the PC.

Doing so may cause them to bump into the unit, or their feet may be entangled in the USB cable, resulting in a fire, electric shock or injury.

- When using the unit in an area where there are passers-by, provide an enclosure around the unit to prevent people from approaching it.

If the Display is not going to be used for any prolonged length of time, unplug the power supply plug from the wall outlet.

Picture noise may occur if you connect / disconnect the cables connected to the input terminals you are currently not watching, or if you turn the power of the video equipment on / off, but it is not a malfunction.

To prevent the spread of fire, keep candles or other open flames away from this product at all times.



CAUTION

If problems or malfunction occur, stop using immediately.

■ If problems occur, unplug the power supply plug.

- Smoke or an abnormal odour come out from the unit.
- No picture appears or no sound is heard, occasionally.
- Liquid such as water or foreign objects got inside the unit.
- The unit has deformed or broken parts.

If you continue to use the unit in this condition, it could result in fire or electric shock.

- Turn the power off immediately, unplug the power supply plug from the wall outlet, and then contact the dealer for repairs.
- To cut off the power supply to this Display completely, you need to unplug the power supply plug from the wall outlet.
- Repairing the unit yourself is dangerous, and shall never be done.
- To enable to unplug the power supply plug immediately, use the wall outlet which you can reach easily.

■ Do not touch the unit directly by hand when it is damaged.

Electric shock could occur.

■ When using the LCD Display

Do not bring your hands, face or objects close to the ventilation holes of the Display.

- Heated air comes out from the ventilation holes at the top of Display will be hot. Do not bring your hands or face, or objects which cannot withstand heat, close to this port, otherwise burns or deformation could result.

4 people are required to carry or unpack this unit.

- If this is not observed, the unit may drop, resulting in injury.

Always work in a team of 4 persons when attaching or removing the speakers supplied in the accessory.

- The display unit may fall down and it may cause injury.

Be sure to disconnect all cables and overturn prevention accessories before moving the Display.

- If the Display is moved while some of the cables are still connected, the cables may become damaged, and fire or electric shock could result.

Do not apply too much force or impact shock.

- The front panel may crack, resulting in injury.

Disconnect the power supply plug from the wall socket as a safety precaution before carrying out any cleaning.

- Electric shocks can result if this is not done.

Clean the power cable regularly to prevent it becoming dusty.

- If dust built up on the power cord plug, the resultant humidity can damage the insulation, which could result in fire. Pull the power cord plug out from the wall outlet and wipe the mains lead with a dry cloth.

Do not step on, or hang from the display or the Pedestal.

- They might tip over, or might be broken and it may result in injury. Pay special attention to the children.

Do not reverse the polarity (+ and -) of the battery when inserting.

- Mishandling the battery may cause its explosion or leakage, resulting in fire, injury or damage to surrounding properties.
- Insert the battery correctly as instructed. (see page 12)

Do not use batteries with the outer cover peeling away or removed.

(The outer cover is attached to the battery for safety. It must not be removed. Doing so may cause short circuits.)

- Mishandling the batteries may cause the batteries to short circuit, resulting in fire, injury or damage to surrounding properties.

Remove the batteries from the remote control transmitter when not using for a long period of time.

- The battery may leak, heat, ignite or burst, resulting in fire or damage to surrounding properties.

Do not burn or breakup batteries.

- Batteries must not be exposed to excessive heat such as sunshine, fire or the like.

Do not turn the Display upside down.

Do not position the unit with its liquid crystal panel facing upright.

Parts of the unit become hot.

- Even when the temperature of parts of the front panel surface, top and rear of the unit has risen, these temperature rises will not pose any problems in terms of performance or quality.

Precautions for use

Cautions when installing

Do not set up the Display outdoors.

- The Display is designed for indoor use.

Install this unit at a location which can support the weight of the unit.

- Use the installation bracket that conforms to VESA standards

Environmental temperature to use this unit

- When using the unit where it is below 1 400 m (4 593 ft) above sea level: 0 °C to 40 °C (32 °F to 104 °F)
- When using the unit at high altitudes (1 400 m and higher and below 2 800 m (9 186 ft) above sea level): 0 °C to 35 °C (32 °F to 95 °F)

Do not install the unit where it is 2 800 m (9 186 ft) and higher above sea level.

- Failure to do so may shorten the life of the internal parts and result in malfunctions.

We are not responsible for any product damage, etc. caused by failures in the installation environment even during the warranty period.

Do not place the display where it may be affected by salt or corrosive gas.

- Failure to do so may shorten the life of the internal parts and result in malfunctions due to corrosion.

Required space for ventilation

- When using the Pedestal (optional accessory), leave a space of 10 cm (3 15/16") or more at the top, left and right, and 5 cm (1 31/32") or more at the rear, and also keep the space between the bottom of the display and the floor surface.

If using some other setting-up method (wall-hanging, etc.), follow the manual of it. (If there is no specific indication of installation dimension in the installation manual, leave a space of 10 cm (3 15/16") or more at the top, bottom, left and right, and 5 cm (1 31/32") or more at the rear.)

Minimum distance:

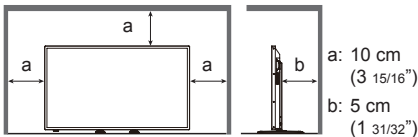

- Operation of this unit is guaranteed up to an ambient temperature of 40 °C (104 °F). When installing the unit in a case or chassis, be sure to provide adequate ventilation with a cooling fan or ventilation hole so that the surrounding temperature (inside the case or chassis) including the temperature of the front surface of the liquid crystal panel can be kept at 40 °C (104 °F) or less.

About the screws used when using a wall hanging bracket that conforms to VESA standards

Inch model	Screw pitch for installation	Depth of screw hole	Screw (quantity)
75	400 mm × 400 mm	25 mm	M6 (4)

Be careful of the movable structure of the power indicator and remote control sensor.

- As factory default, the power indicator and remote control sensor are stored in the main unit. In normal cases, pull the remote control sensor box from the end face of the unit until it gets locked at the designated position. Depending on the setup condition such as when using the multi display, store the remote control sensor in the main unit. (see page 21)

Depending on the temperature or humidity conditions, uneven brightness may be observed. This is not a malfunction.

- This unevenness will disappear while applying current continuously. If not, consult the distributor.

Cleaning and maintenance

First, remove the mains plug from the mains socket.

The front panel surface has been specially treated.

Wipe the surface of the front panel gently using only a cleaning cloth or a soft, lint-free cloth.

- If the surface is particularly dirty, wipe with a soft, lint-free cloth which has been soaked in pure water or water in which neutral detergent has been diluted 100 times, and then wipe it evenly with a dry cloth of the same type until the surface is dry.

Wipe off dirt on the IR transmission part with soft cloth.

- Wipe off dirt on the IR transmission part with soft cloth once a day.

If malfunction is due to dirt on the IR transmission part, simply wiping it off lightly can recover the performance.

If dirt is sticky, wipe it off with cloth wrung out of neutral detergent diluted with water and then wipe the part with dry cloth.

- If the substance such as the material of the supplied pen is stuck on the glass surface, wipe it with a wet cloth.

Note that if a deep scratch is caused by using objects other than the supplied pen, it may not be wiped off.

- Do not scratch or hit the surface of the front panel with fingernails or other hard objects, otherwise the surface may become damaged. Furthermore, avoid contact with volatile substances such as insect sprays, solvents and thinner, otherwise the quality of the surface may be adversely affected.

If the cabinet becomes dirty, wipe it with a soft, dry cloth.

- If the cabinet is particularly dirty, soak the cloth in water to which a small amount of neutral detergent has been added and then wring the cloth dry. Use this cloth to wipe the cabinet, and then wipe it dry with a dry cloth.
- Do not allow any detergent to come into direct contact with the surface of the Display. If water droplets get inside the unit, operating problems may result.
- Avoid contact with volatile substances such as insect sprays, solvents and thinner, otherwise the quality of the cabinet surface may be adversely affected or the coating may peel off. Furthermore, do not leave it for long periods in contact with articles made from rubber or PVC.

Usage of a chemical cloth

- Do not use a chemical cloth for the panel surface.
- Follow the instructions for the chemical cloth to use it for the cabinet.

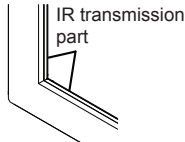

Touch panel

Carefully observe the following instructions as the display has an optical touch panel.

Do not expose the display to direct sunlight or strong light source during use.

- Otherwise malfunction may occur since the optical touch panel of the display uses infrared rays.

Always use a finger or the supplied pen to operate the touch panel. Do not use a hard or sharp tip such as nail, ball-point pen, and pencil.

When using any other infrared device, keep a distance to prevent erroneous operation.

When installing multiple units

When installing multiple units side by side, infrared rays of each unit may penetrate into the IR transmission parts of the adjacent displays, resulting in malfunction of touch panels.

Install the units in such a way that the displays are not affected mutually.

Disposal

When disposing the product, ask your local authority or dealer about the correct methods of disposal.

Introduction

Checking the accessories

Check that you have all accessories.

- Operating Instructions**
(CD-ROM × 1)

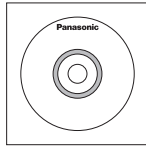

- Power Supply Cord**
(Approx. 2 m)

- 1JP155AF1U

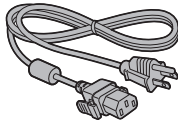

- 1JP155AF1W

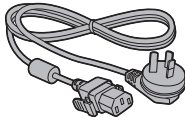

- 2JP155AF1W

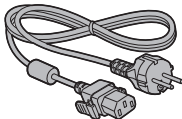

- 3JP155AF1W

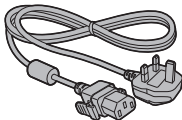

- Remote Control × 1**
• DPVF1671ZA



- Batteries for the Remote Control Transmitter × 2**
(AA/R6/LR6 type)

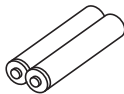

- Pen × 1**
• TKR5ZA45001

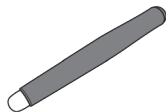

- Clamper × 3**
• DPVF1697ZA



- Speaker × 1**
• DPVF1698ZA

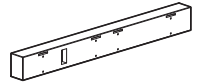

- Speaker Mounting Clasp × 2**
• DPVF1709ZA (Left)
• DPVF1710ZA (Right)

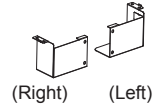

(These clasps are assembled with the speaker and supplied with it.)

- Screw for Mounting the Speaker (M3) × 4**
• DPVF1701ZA



- Speaker Cable × 2**
(Approx. 0.7 m)
• DPVF1702ZA



Attention

- Store small parts in an appropriate manner, and keep them away from young children.
- The part numbers of accessories are subject to change without notice.
(The actual part number may differ from the ones shown above.)
- In case you have lost accessories, please purchase them from your dealer. (Available from the customer service)
- Dispose the packaging materials appropriately after taking out the items.

Remote Control Batteries

Open the battery cover.

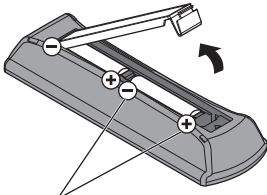

AA/R6/LR6 type

Insert batteries and close the battery cover.

(Insert starting from the ⊖ side.)

Note

- Incorrect installation of the batteries can cause battery leakage and corrosion that will damage the remote control.
- Disposal of batteries should be done in an environment-friendly manner.

Take the following precautions.

1. Batteries shall always be replaced as a pair.
2. Do not combine a used battery with a new one.
3. Do not mix battery types (example; manganese dioxide battery and alkaline battery etc.).
4. Do not attempt to charge, disassemble, or burn used batteries.
5. Do not burn or breakup batteries.

Moreover, batteries must not be exposed to excessive heat such as sunshine, fire or the like.

■ Button and indicator

Back side

Control button

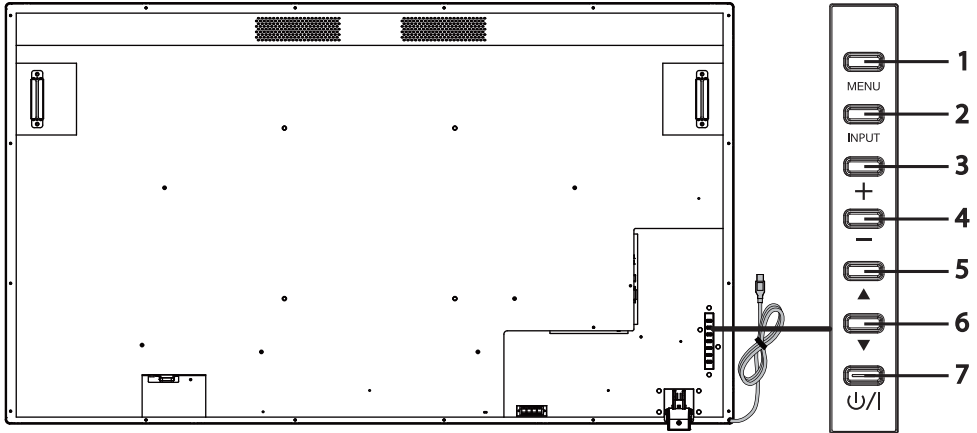

- | | | |
|---|-----------------------------|---|
| 1 | [MENU] button | It shows the on-screen display (OSD) menu. |
| 2 | [INPUT] button | It shows the OSD menu and changes the input source.
You can select [HDMI1], [HDMI2], [DVI-D], [PC], and [USB] with the up (▲) / down (▼) buttons. |
| 3 | Plus (+) button | It increases the volume. |
| 4 | Minus (-) button | It lowers the volume. |
| 5 | Up (▲) button | It moves up the item highlighted in the OSD menu. |
| 6 | Down (▼) button | It moves down the item highlighted in the OSD menu. |
| 7 | [POWER] button (⏻/⏿) | It turns ON/OFF the power supply. This button cannot be operated when the power indicator is turned off. In this case, turn on the Main power switch. (see page 14) |

Back side

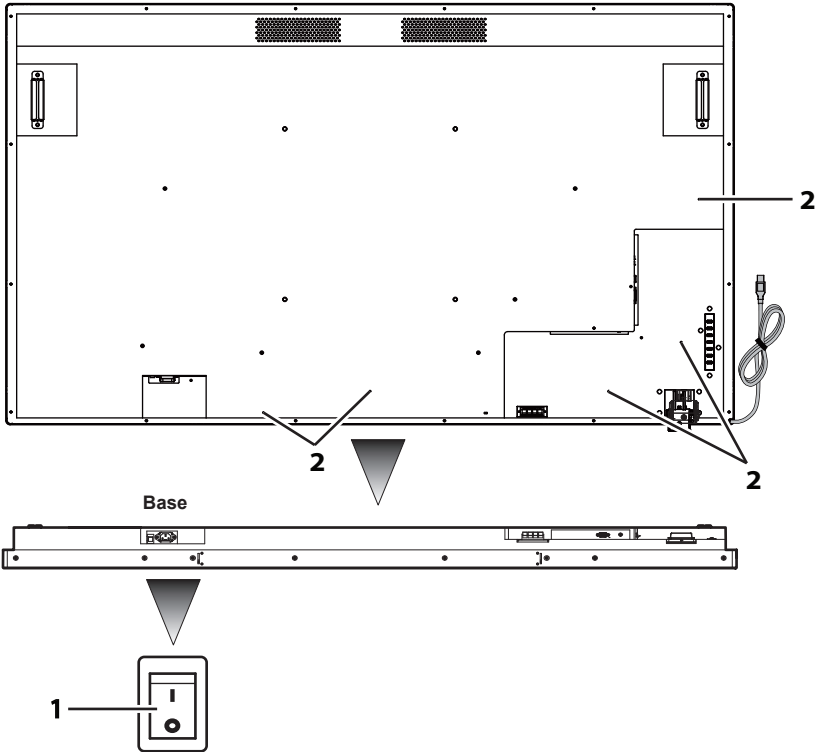

1 Main power switch

It turns "Off (O) / On (I)" the main power supply. It is used for starting / stopping power supply to the device.

2 Hole for cable clamp installation

It is used for fastening cable with the main unit.

Cable and terminal

Back side

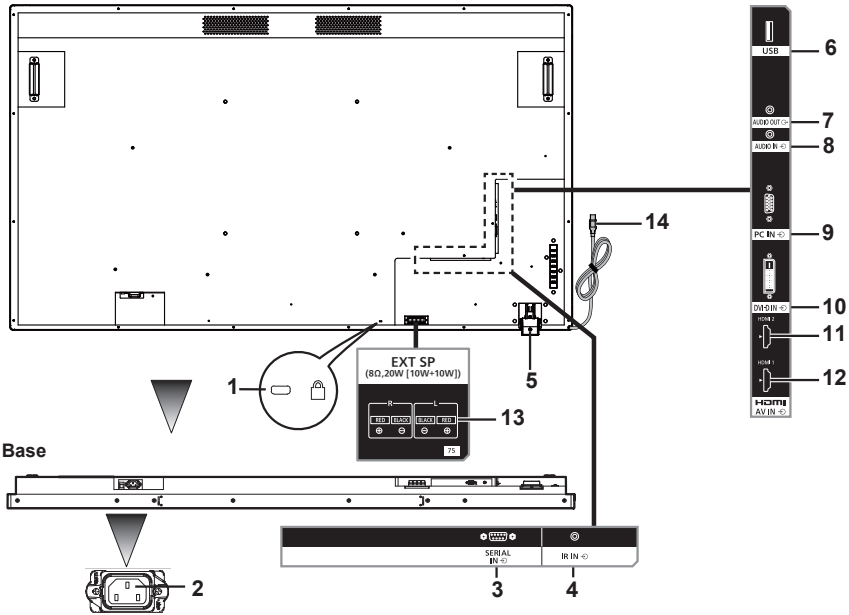

- | | | |
|-----------|--|--|
| 1 | Hole for installing theft prevention lock | It is used for security and theft prevention. |
| 2 | AC IN (3-pin, with earthing terminal) | It is connected with the power supply cord provided in accessories. For Class I products, it is mandatory to connect the main power supply having earthing. |
| 3 | SERIAL IN | It is used for connecting to a PC for controlling the main unit. |
| 4 | IR IN | It is an IR input terminal that is connected with an IR cable. Please contact your distributor for purchasing an IR cable. |
| 5 | Remote control sensor / Power indicator | Remote control sensor: It receives signals from the remote control.
Power indicator: It shows the status of LCD display. |
| 6 | USB | It is a USB input terminal for USB flash drives. |
| 7 | AUDIO OUT | This terminal is for connecting a speaker having amplifier. It will output audio when [AUDIO OUT] is specified in [Sound] - [Output Select]. Output can be adjusted with the [VOL] button (+/-) of the remote control. |
| 8 | AUDIO IN | It is used for connecting audio output cables of external devices such as PC, VCR, and DVD player. For HDMI input, you can select [AUDIO IN] in [Sound] - [Audio Source]. [AUDIO IN] is default in DVI-D/PC input. |
| 9 | PC IN | It is used for connecting with the analogue video signal output terminal of a PC. |
| 10 | DVI-D IN | It is connected with a digital video signal output terminal such as a PC. |
| 11 | HDMI 1 | It is used for connecting with a device compatible with audio / video signal of HDMI interface. |
| 12 | HDMI 2 | It is used for connecting with a device compatible with audio / video signal of HDMI interface. |
| 13 | EXT SP | It is connected with L/R and +/- terminal of the speaker provided as accessory.
It will output audio when [EXT SP] is specified in [Sound] - [Output Select]. Output can be adjusted with the [VOL] button (+/-) of the remote control. |
| 14 | USB cable for touch panel | It is connected to a PC's USB terminal for using the touch panel. |

Remote control

- | | | |
|----|-------------------------------|--|
| 1 | [POWER] | It turns ON/OFF the power supply. Remote control cannot be operated when the power indicator is turned off. |
| 2 | [AUTO ADJUST] | It shows the automatic adjustment selection menu during PC input. |
| 3 | [PICTURE STYLE] | It shows the settings menu of the image mode for the displayed input. |
| 4 | [SOUND STYLE] | It shows the settings menu of the audio mode for the displayed input. |
| 5 | [PICTURE] | It shows the image settings menu for the displayed input. |
| 6 | [SOUND] | It shows the audio settings menu for the displayed input. |
| 7 | [SET UP] | It shows the [Setup] menu. |
| 8 | [ASPECT] | It shows the settings menu of aspect ratio. |
| 9 | [MENU] | It turns ON/OFF the OSD menu. |
| 10 | [RETURN] | It is used for going back to the previous menu screen. |
| 11 | Cursor buttons | They are used for operating the menu screen. |
| 12 | [OK] | It is used for selecting menu items. |
| 13 | [EXIT] | It turns OFF the OSD menu. |
| 14 | [INFO] | It shows the selected input source. |
| 15 | [MEDIA CONTROL] | It provides various control functions of a specific menu. Function of each button will appear in OSD in the colour of the respective button. |
| 16 | [VOL] | Pressing the plus (+) side will increase the audio output level.
Pressing the minus (-) side will decrease the audio output level. |
| 17 | [SLEEP] | It adjusts the sleep timer. |
| 18 | [MUTE] | It mutes the audio. Press once again to unmute.
Turning off the power supply and changing the volume level will restore the audio. |
| 19 | [INPUT] | It is used for changing the input source. |
| 20 | [HDMI] | It is used for selecting HDMI input. |
| 21 | [DVI] | It is used for selecting DVI-D input. |
| 22 | [PC] | It is used for selecting PC input. |
| 23 | Media operation button | It provides control functions when a media file is playing. Rewind (<<), Play (>), Fast forward (>>), Previous (<<), Stop (□), Pause (⏏), Next (>>). |
| 24 | [USB] | It is used for selecting USB input. |
| 25 | [-] | Not supported in this device. |

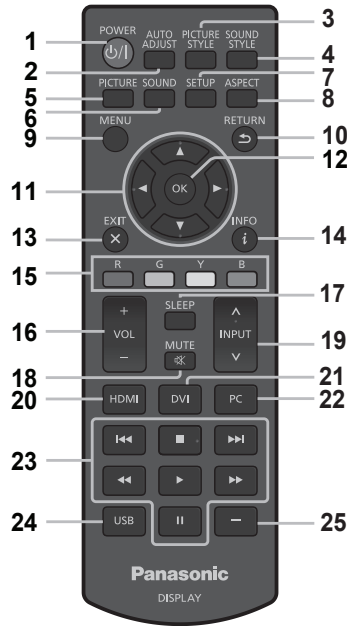

Installation

Connecting and fixing the power supply cord

Back side of the unit

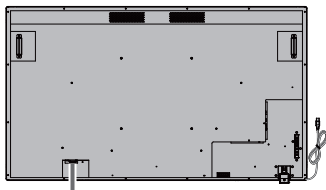

Fixing the power supply cord

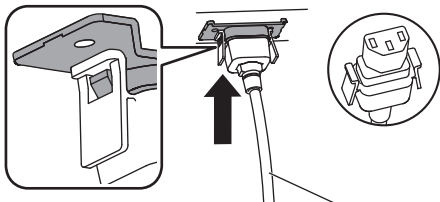

Power supply cord (supplied)

Insert the connector in the main unit

Insert until you hear the clicking sound.

Note

- Check that both sides are locked.

When removing the power supply cord

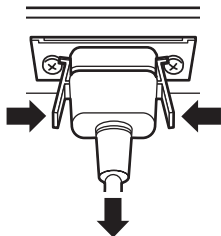

Remove while pressing the knobs located next to the connector.

Note

- When removing the power supply cord, make sure to first remove the power supply plug on the power socket side.
- The power supply cord provided in the accessories is for exclusively using with the device. Do not use it for any other purpose.

Fixing the connection cables

Note

- Three clampers are provided as accessories with the device. When not using the touch panel, use one of the clampers to fix the USB cable for touch panel at the position of A. Moreover, with the other two clampers, fix the other cables at the position of B. If you wish to purchase clampers, please contact your dealer. (Available from the customer service)

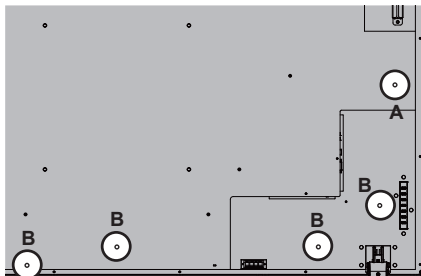

1. Mounting the clampers

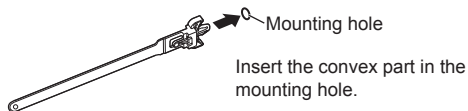

Insert the convex part in the mounting hole.

Note

- Once you mount the clampers in the clamer mounting holes, you will not be able to remove them.

2. Bundling the cables

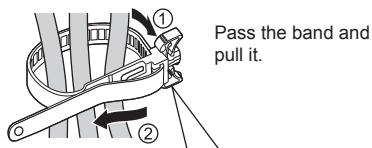

Pass the band and pull it.

Loosening the band

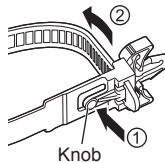

Pull the tip of the band while pressing the knob.

Using the touch panel

- 1 Turn off the Main power switch of the display.
- 2 Connect the computer and the USB cable of the display.
- 3 Connect the computer and the video input terminal of the display.
- 4 Turn on the Main power switch of the display. If required, press the [POWER] button of the remote control to turn on the display.

■ Display settings

Please make the following display settings.

- Switch the input signal to the video input from the computer.
- Set the screen position such that the computer's screen correctly appears on the display.

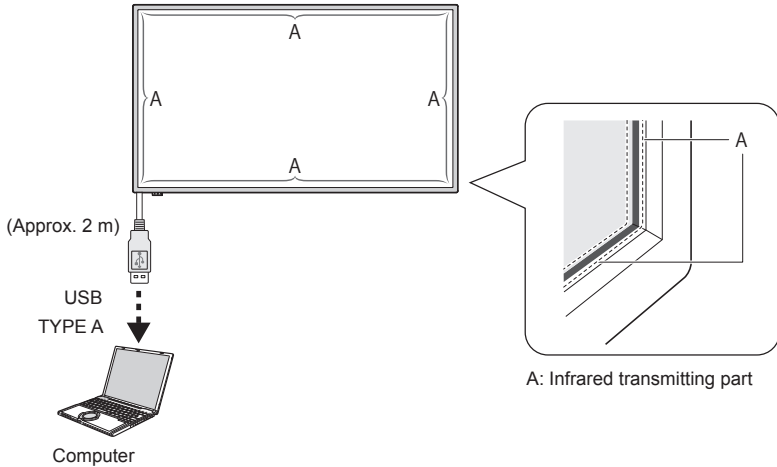

Note

- Pulling the USB cable with excessive force may result in the breakdown of the touch panel. Therefore, handle it carefully.
- For preventing disconnection of the USB cable for touch panel, fix it with the device by using the clammer. (see page 17)
- Wipe off dirt on the infrared transmitting part with a soft cloth.

Wipe off dirt on the infrared transmitting part with a soft cloth once in a day. When a defect has occurred because of dirt on the infrared transmitting part, lightly wiping it will restore the function. If the infrared transmitting part is heavily soiled, dip the cloth in a neutral cleaning agent diluted with water and firmly squeeze it. Use this cloth and gently clean the infrared transmitting part. Finally, wipe it with a dry cloth.

Using WhiteBoard software

WhiteBoard software allows you to use various functions, for example, you can capture documents and pictures, draw with pen, etc.

- 1 Obtain the WhiteBoard software (Windows / Mac) from the support site below.
<https://panasonic.net/cns/prodisplays/>
- 2 For details of operation, refer to the manual of WhiteBoard software on the site above.

Mounting sequence of the speaker

Mount the speaker (supplied).

A cross slot screw driver is required for assembling. Therefore, arrange it in advance.

1 Preparing the display

Work in a team of 4 persons when installing.

Spreading out a soft cloth, etc., place the display with the screen facing down.

- Be careful not to damage the display screen, for example, by dragging it.
- When placing the display with the screen facing down, or lifting it up, never hold or put pressure on the front panel. Inside of the front panel may be damaged.

2 As shown in the figure below, mount the speaker on the display.

Fix the speaker with 2 speaker mounting clasps and 4 speaker mounting screws (supplied).

Tightening torque: 0.5 to 0.8 N·m

Note

- Speaker mounting clasps are assembled with the speaker and supplied with it.

■ In the case of lateral placement

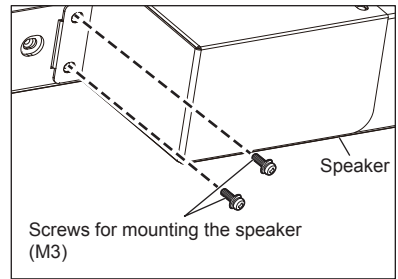
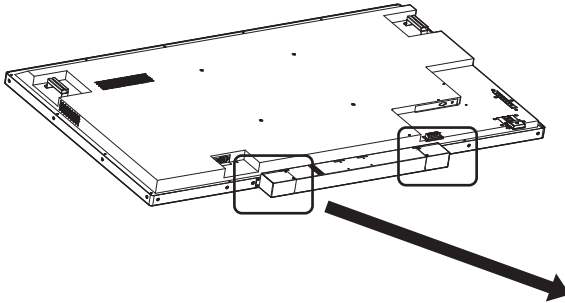

*Fix the opposite side in the symmetric position.

■ In the case of vertical placement

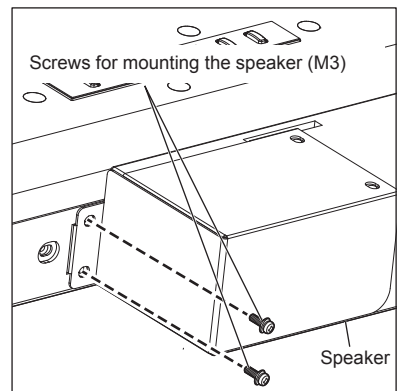
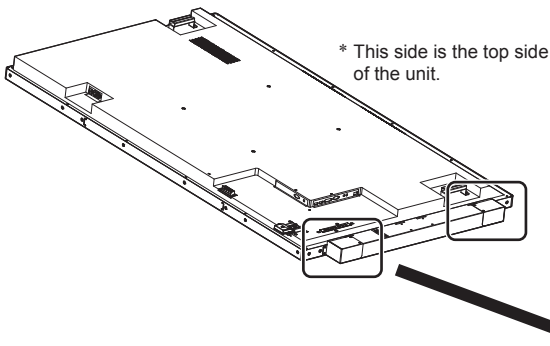

*Fix the opposite side in the symmetric position.

3 Connecting the speaker cables

With the 2 speaker cables (supplied), connect the EXT SP terminal of the display and the speaker.

Note

- Connect the R terminal on the display to the R terminal on the speaker, and the same applies for the L terminals on them.
- Connect the red terminal on the display to the red terminal on the speaker, and the same applies for the black terminals on them.
- When connecting the speaker cable, please take precaution so that short circuit doesn't happen in the core wire.

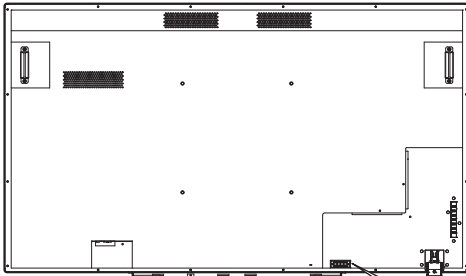

1. While pushing the lever

2. Insert the cable
3. Release the lever

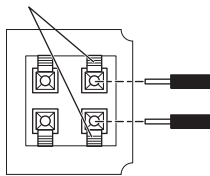

1. Pushing down the lever

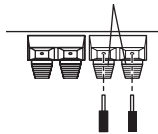

2. Insert the cable

3. Return the lever

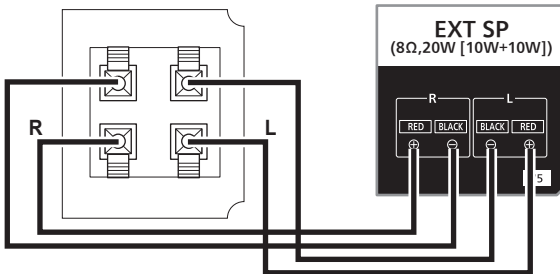

Mount the clammer (supplied) at the following places, and then fix the cable.

When the cable is long, bundle and fix the cable using this clammer.

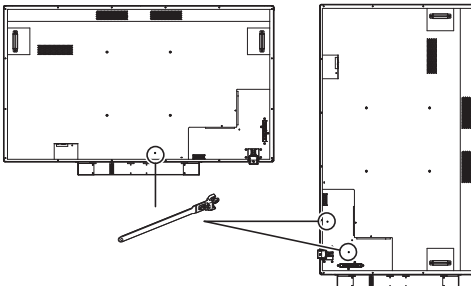

Operation

Turn on the power supply of all connected devices

- 1 Turn on the power supply of all connected devices such as PC and DVD player.
- 2 Set the remote control sensor.

Before using the remote control, decide the position of remote control sensor of LCD display.

Remote control sensor is the small black box located on the left side of the back of LCD display. Until the sensor gets locked at the designated position, push the position of A with thumb etc. and slide it in the downward direction (refer to bottom right of the illustration).

Follow these steps in the opposite order for returning the sensor to its original position.

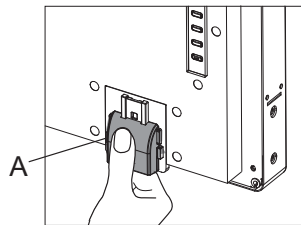
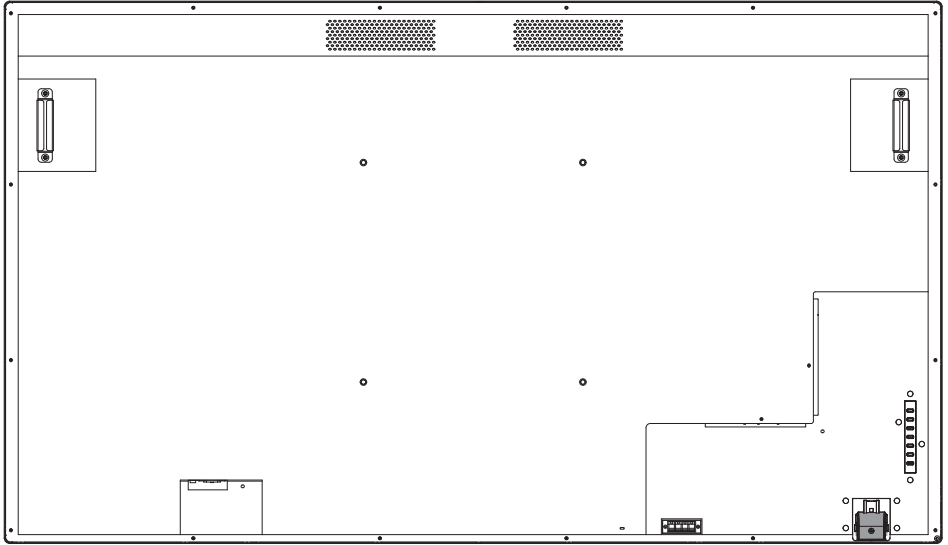

When the remote control sensor is stored

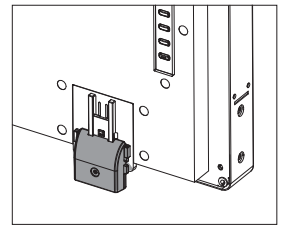

When the remote control sensor is used

3 Turn on the Main power switch.

The power indicator will light up, and you can now operate remote control and control buttons on the back side, avail serial control, and enable the scheduler.

When the Main power switch is off (power indicator is light out), control buttons on the back side, remote control, and the settings of scheduler will not work. For using these, check that the Main power switch is on (power indicator has light up).

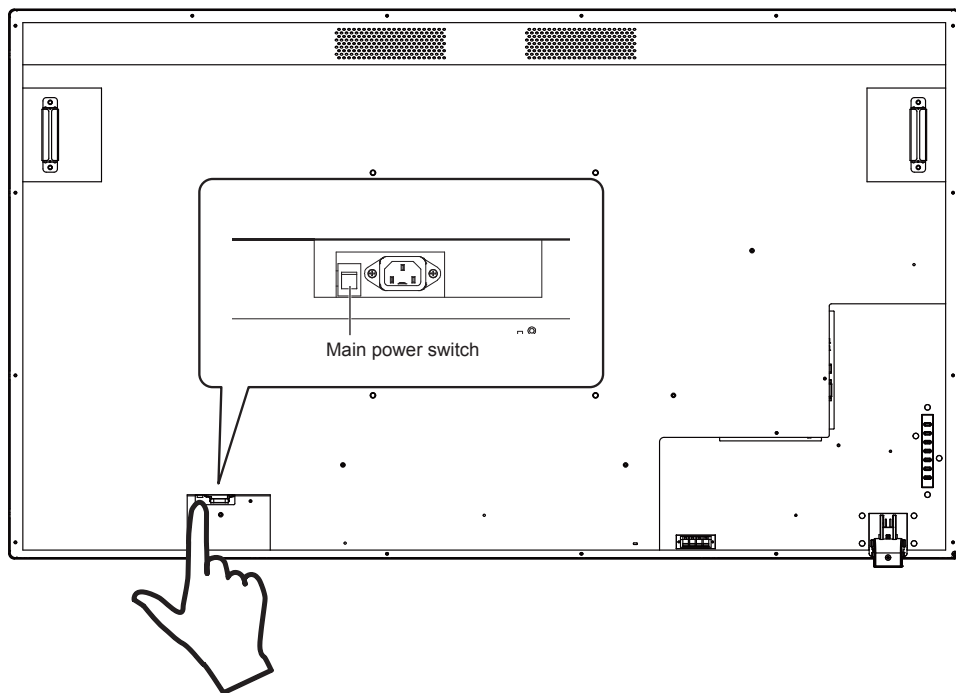

4 Turn on the device.

Press the [POWER] button located on the left side of the device, or the [POWER] button located on top left of the remote control.

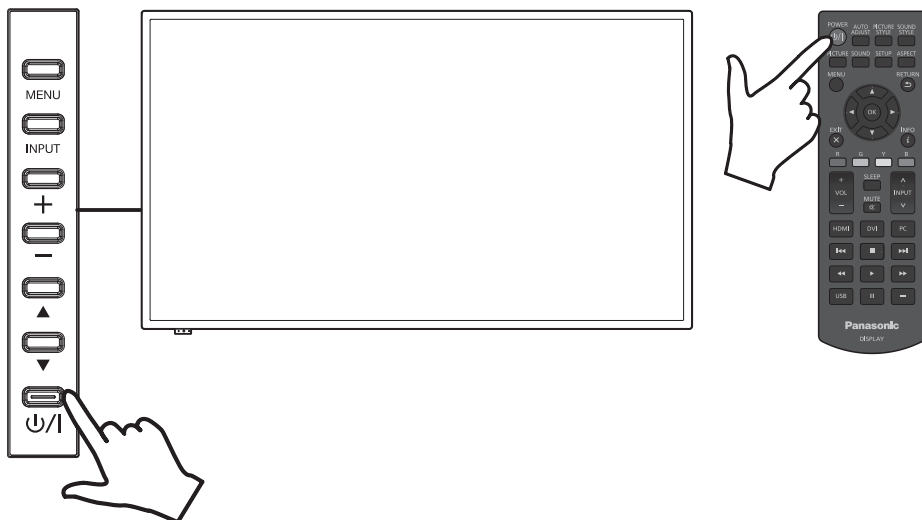

Specifications

Main unit

Model No.	TH-75BQE1W
Type	Touch screen LCD display
Power source	110 – 240 V ~ (110 – 240 V alternating current), 50/60 Hz
Power consumption	370 W
	Power off with the Main power switch: approx. 0 W Power off with the remote control: approx. 0.5 W
LCD display panel	VA panel (Direct LED backlight)
	75-inch model (16:9 aspect ratio)
Screen size	1 650 mm (W) × 928 mm (H) × 1 893 mm (diagonal) / 64.9" (W) × 36.5" (H) × 74.5" (diagonal)
Number of pixels	8 294 400 pixels (3 840 (horizontal) × 2 160 (vertical))
Operating condition	Temperature: 0 °C – 40 °C (32 °F – 104 °F)*1 Humidity: 20 % – 80 % (no condensation)
Storing condition	Temperature: -20 °C – 60 °C (-4 °F – 140 °F) Humidity: 20 % – 80 % (no condensation)
Operating Time	16 hours/day
HDMI input terminal	TYPE A Connector*2 × 2
HDMI 1 / HDMI 2	Audio signal: Linear PCM (sampling frequencies - 48 kHz, 44.1 kHz, 32 kHz)
Digital RGB input terminal	DVI-D 24 Pin × 1
DVI-D IN	
PC input terminal	Mini D-sub 15 Pin (Compatible with DDC2B) × 1
PC IN	R/G/B 0.7 Vp-p (75 Ω) (without sync signal)
	HD/VD TTL
Audio input terminal	Stereo mini jack (M3) × 1, 0.5 Vrms, shared with DVI-D IN and PC IN
AUDIO IN	
Audio output terminal	Stereo mini jack (M3) × 1, 0.5 Vrms Output: Variable (-∞ – 0 dB) (1 kHz 0 dB input, 10 kΩ load)
AUDIO OUT	
Serial input terminal	External Control Terminal D-sub 9 Pin × 1 RS-232C compatible
SERIAL IN	
External speaker terminal	8Ω, 20 W [10 W + 10 W] (10 % THD)
EXT SP	
IR input terminal	Stereo mini jack (M3) × 1
IR IN	
USB flash drive terminal	TYPE A USB connector × 1 DC 5V / 1A (USB 3.0 is not supported.)
USB	
Outer dimensions (W × H × D)	1 710 mm × 989 mm × 102 mm / 67.3" × 39.0" × 4.02"
	1 710 mm × 1 072 mm × 102 mm / 67.3" × 42.3" × 4.02" (horizontal installation / when the speaker mounted) 989 mm × 1 793 mm × 102 mm / 39.0" × 70.6" × 4.02" (vertical installation / when the speaker mounted)
Mass	Approx. 66.0 kg / 145.5 lbs (Approx. 68.0 kg / 150.0 lbs when the speaker mounted.)
Cabinet material	Front: metal / Back cover: metal

Remote control

Power source	DC 3 V (battery (AA/R6/LR6 type) × 2)
Operating range	Approx. 5 m (from the front of the remote control sensor)
Mass	Approx. 113 g / 0.3 lbs (including batteries)
Outer dimensions (W × H × D)	160 mm × 50 mm × 20 mm / 6.3" × 2.0" × 0.8"

Speaker

Impedance	8 Ω
Rated input	20 W [10 W + 10 W]
Outer dimensions (W × H × D)	763 mm × 82 mm × 59 mm / 30.1" × 3.3" × 2.4"
Mass	Approx. 2.0 kg / 4.4 lbs
Cabinet material	Resin

*1 Environmental temperature to use this unit at high altitudes (1 400 m (4 593 ft) and higher and below 2 800 m (9 186 ft) above sea level); 0 °C to 35 °C (32 °F to 95 °F)

*2 VIERA LINK is not supported.

(for the U.S.A and Puerto Rico)

Panasonic System Solutions Company of North America
Division of Panasonic Corporation of North America
Two Riverfront Plaza
Newark, NJ 07102

**PANASONIC PROFESSIONAL DISPLAY
Limited Warranty**

Models or Parts	Part Warranty	Labor Warranty
All Professional Display Model	3 Years	3 Years
Exceptions		
All Panasonic accessories: e.g. mounting kit, input signal module, cables, remote control, filter, batteries.	1 Year	1 Year

Panasonic System Solutions Company of North America (referred to as "the Panasonic") will repair the Professional Video product (the "Product") and its accessories as defined in the attached table, with new or refurbished parts, free of charge in the continental USA, during the applicable warranty coverage period from the original date of purchase in the event of a defect in materials or workmanship as follows: On-Site, carry-in, or mail-in service within the **continental USA** may be obtained during the warranty period by contacting Panasonic's Technical Support Center at the following toll free number **855-772-8324** or via

e-mail: ProDisplaySupport@us.panasonic.com. In case of mail-in service the customer is responsible for the cost of delivering of the Product to Panasonic's facility, while Panasonic will pay for the return transportation of the repaired Product to the customer. For out of warranty Product units submitted for repairs or for in warranty units submitted by customers outside of the continental USA, shipping arrangements and cost (both ways) are the customer's responsibility. Panasonic will also not be responsible for any costs associated with determining the source of system problems or for removing and installing the faulty Product.

This warranty is extended only to the original purchaser and is nontransferable. A purchase receipt or other proof of date of original purchase will be required before warranty service is rendered. Whenever the date of original purchase cannot be satisfactorily determined, the date of manufacture of the unit will be deemed to be the effective date of the warranty. Panasonic reserves the right to audit and reject any warranty claim that cannot be substantiated. This warranty only covers failures due to defects in materials or workmanship which occur during normal use of the Product.

The warranty **DOES NOT** cover damage to the display and its components which occur in shipping; failures which are caused by products not supplied by Panasonic; failures which result from accident, misuse, abuse, neglect, mishandling, misapplication, alteration, modification, faulty installation, setup adjustments, improper antenna, inadequate signal pickup, maladjustment of user controls, improper operation, power line surge, improper voltage supply, lightning damage, smoke or chemical vapors contamination, air conditioning, humidity control or other environmental conditions; failure to maintain the product in accordance with the applicable Operating Instructions; service by anyone other than an authorized repair facility; damage that is attributable to acts of violence, war, acts of God or force majeure.

The warranty does not cover damage which occurs to the display or its components caused by excessive continual usage which goes beyond the operational time described in the Operating Instructions. The warranty does not cover units of which the model and serial number label has been defaced, modified, tampered with or removed. The warranty does not cover consumable parts.

LIMITS AND EXCLUSIONS

PANASONIC SHALL NOT BE LIABLE FOR ANY INDIRECT, INCIDENTAL, CONSEQUENTIAL, PUNITIVE OR SPECIAL DAMAGES, INCLUDING, BUT NOT LIMITED TO, LOSS OF DATA, LOSS OF PROFIT, LOSS OF REVENUE, OR LOSS OF BUSINESS OR GOODWILL, SUFFERED BY ANY PERSON, AND RESULTING FROM THE USE OF THIS PANASONIC PROFESSIONAL DISPLAY PRODUCT, OR ARISING OUT OF ANY BREACH OF THIS WARRANTY. ALL EXPRESS WARRANTIES SPECIFIED ABOVE ARE IN LIEU OF ALL OTHER WARRANTIES, EXPRESS, IMPLIED OR STATUTORY, INCLUDING BUT NOT LIMITED TO, THE IMPLIED WARRANTIES OF MERCHANTABILITY AND FITNESS FOR A PARTICULAR PURPOSE. Some states do not allow the exclusion or limitation of incidental or consequential damages, or limitations on how long an implied warranty lasts, so the above limitations or exclusions may not apply to you.

If you have a problem with this product that is not handled to your satisfaction, then write the Consumer Affairs Department at the Panasonic's address indicated above.

Panasonic Canada Inc.
 5770 Ambler Drive, Mississauga, Ontario L4W 2T3
LIMITED WARRANTY STATEMENT

Panasonic Canada Inc. (also known as PCI) warrants this product to be free of defects in material and workmanship under normal use during the applicable warranty coverage period described below. PCI agrees to repair, or at its option, exchange any part that becomes defective. However, the product must be purchased and serviced in Canada. The product or part that shows evidence of defect must be delivered prepaid or carried in to an authorized Panasonic Broadcast Service Center. This warranty does not cover shipping costs.

The warranty coverage period is one year for both parts and labour beginning with the date of original end user purchase, subject to the exceptions as stated below. Repaired or replacement parts supplied during the warranty coverage period carry the unexpired portion of the original warranty coverage period. Proof of product purchase is a condition of warranty service. The owner must produce the product purchase receipt or other satisfactory evidence of date of original purchase.

This warranty does not apply to external appearance items, such as handles, knobs, switches, buttons, etc. It also does not apply to accessories of the product. The product, installed, altered, repaired or misused in any way that affects the reliability of or detracts from the performance of the product.

For products requiring routine preventive maintenance, that maintenance must be performed in order to maintain warranty coverage.

Serial numbers that have been altered, defaced or removed void this warranty. This warranty does not cover replacements or repairs necessitated by loss or damage resulting from any cause beyond the control of PCI.

Marking or related images (sometimes called "burn-in") resulting from the display of fixed images on video display products are not defects and are not covered under this warranty.

THIS EXPRESS, LIMITED WARRANTY IS IN LIEU OF ALL OTHER WARRANTIES, EXPRESS OR IMPLIED, INCLUDING ANY IMPLIED WARRANTIES OF MERCHANTABILITY AND FITNESS FOR A PARTICULAR PURPOSE. IN NO EVENT WILL PANASONIC CANADA INC. BE LIABLE FOR ANY SPECIAL, INDIRECT OR CONSEQUENTIAL DAMAGES.

In certain instances, some jurisdictions do not allow the exclusion or limitation of incidental or consequential damages, or the exclusion of implied warranties, so the above limitations and exclusions may not be applicable.

WARRANTY COVERAGE PERIOD EXCEPTIONS

Item	Parts	Labour
Video Tape	30 days—Replacement only (Content not covered)	N/A
P2/SD Cards	(Content not covered)	N/A
Video Heads	1 year or 2,000 hrs. (priorated) whichever comes first	1 year or 2,000 hrs. whichever comes first
D5 Video heads	1 year or 1,000 hrs. whichever comes first	1 year or 1,000 hrs. whichever comes first
Maintenance Items	2 years	2 years
Colour Camera CCD Imaging Block	2 years	2 years
All LCD Monitors	2 years (burn-in not covered)	2 years
*DLP™ Monitors	3 years or 17,000 hrs. whichever comes first	3 years or 17,000 hrs. whichever comes first
1 LCD Projectors above 2,500 ANSI Lumens	3 years or 2,500 hrs. whichever comes first	3 years or 2,500 hrs. whichever comes first
*LCD Projectors below 2,500 ANSI Lumens	3 years or 1,500 hrs. whichever comes first	3 years or 1,500 hrs. whichever comes first
Projector Lamps	50% of the rated lamp life or 1 year. Whichever comes first	50% of the rated lamp life or 1 year. Whichever comes first
All Plasma displays	2 years (burn-in not covered)	2 years
103 inch Plasma displays	3 years (burn-in not covered)	3 years
Hard Drive Disk Unit	1 year plus balance (if any) of the original Manufacturer's Limited Warranty. (Content not covered)	1 year

* Dust, smoke, rental/staging environment and twenty-four/seven operation, dramatically decreases the interval between performances of routine preventive maintenance required to maintain this warranty coverage.

Warranty Service

If the product needs to be shipped for service, carefully pack (preferably in the original carton) and enclose a letter, detailing the complaint. Send prepaid and adequately insured to the local authorized Panasonic Service Centre in your area or to Panasonic Technical Support and Product Services Department, 5770 Ambler Drive, Mississauga, Ontario, L4W 2T3. Shipping to the latter location requires a return authorization before shipment. No liability is assumed for loss or damage to the product while in transit.

Customer Service

Customer Service Directory

Obtain products information and operative assistant; localize the closer distributor or Service Center; buy spare parts and accessories by our web site to Latin American:

<http://www.lar.panasonic.com>

Also you may contact us directly by our Contact Center:

Panama	800-PANA (800-7262)
Colombia	01-8000-94PANA (01-8000-947262)
Ecuador	1800-PANASONIC (1800-726276)
Costa Rica	800-PANA737 (800-7262737)
El Salvador	800-PANA (800-7262)
Guatemala	1-801-811-PANA (1-801-811-7262)
Chile	800-390-602 From a cell phone: 797-5000
Venezuela	800-PANA-800 (800-7262-800)
Uruguay	0-800-PANA (0-800-7262)
Peru	0-800-00-PANA (0-800-00726)
Argentina	0800-333-PANA (0800-333-7262) 0810-321-PANA (0810-321-7262)
Paraguay	800-11-PANA (800-11-7262)
Dominican Republic	809-200-8000

Mexico Service

To obtain information in the Republic of Mexico contact us at:

[email: atencion.clientes@mx.panasonic.com](mailto:atencion.clientes@mx.panasonic.com)

<http://www.panasonic.com.mx>

Or you may contact us in the next following phones numbers:

01800-VIP-PANA (01800-847-7262) - Interior

(55) 5000-1200 - Mexico D.F. and Metropolitan Area

Disposal of Old Equipment and Batteries

Only for European Union and countries with recycling systems



These symbols on the products, packaging, and/or accompanying documents mean that used electrical and electronic products and batteries must not be mixed with general household waste. For proper treatment, recovery and recycling of old products and used batteries, please take them to applicable collection points in accordance with your national legislation. By disposing of them correctly, you will help to save valuable resources and prevent any potential negative effects on human health and the environment. For more information about collection and recycling, please contact your local municipality. Penalties may be applicable for incorrect disposal of this waste, in accordance with national legislation.



Note for the battery symbol (bottom symbol)

This symbol might be used in combination with a chemical symbol. In this case it complies with the requirement set by the Directive for the chemical involved.

Information on Disposal in other Countries outside the European Union

These symbols are only valid in the European Union.

If you wish to discard these items, please contact your local authorities or dealer and ask for the correct method of disposal.

Notice (U.S.A. only)

Disposal may be regulated in your community due to environmental considerations. For disposal or recycling information, please visit Panasonic website:

<http://www.panasonic.com/environmental>

or call 1-888-769-0149.

Customer's Record

The model number and serial number of this product may be found on its rear panel. You should note this serial number in the space provided below and retain this book, plus your purchase receipt, as a permanent record of your purchase to aid in identification in the event of theft or loss, and for Warranty Service purposes.

Model Number

Serial Number

Panasonic System Solutions Company of North America

Unit of Panasonic Corporation of North America

Executive Office :

Two Riverfront Plaza, Newark, New Jersey 07102

Panasonic Canada Inc.

5770 Ambler Drive

Mississauga, Ontario

L4W 2T3

Panasonic Testing Centre

Panasonic Service Europe, a division of Panasonic Marketing Europe GmbH

Winsbergring 15, 22525 Hamburg, F.R. Germany

Panasonic Corporation

Web Site: <http://panasonic.com>

English